

# Improved Flux Reliability of Lead-Free Solder Alloy Solder Paste Formulated with Rosin and Anti-Crack Resin for Automotive and Other High Reliability Applications

Shantanu Joshi<sup>1</sup>, Jasbir Bath<sup>1</sup>, Mitsuyasu Furusawa<sup>2</sup>, Junichi Aoki<sup>2</sup>, Roberto Garcia<sup>1</sup>, Manabu Itoh<sup>2</sup>,  
<sup>1</sup>Koki Solder America Inc., USA, <sup>2</sup>Koki Company Ltd., Japan.

## Abstract

In recent years, a growing number of electronic devices are being incorporated into automotive and other high reliability end products where the challenge is to make these devices more reliable. The package size of the devices is largely driven by the consumer industry with their sizes getting smaller making it harder to assemble and be reliable at the same time. For automotive and other high reliability electronics product, it is of the utmost priority to secure high reliability because it directly involves human life and safety. Challenges include selecting an appropriate solder alloy and having good reliability of the solder paste flux.

For solder alloys, much development has been done and is in progress. For the solder paste flux, it is important that the flux intended for automotive and other high reliability applications should have reliable insulation resistance even in an atmosphere of high temperature and high humidity. To meet these requirements, a type of 'crack free' flux paste was developed to inhibit cracking under extreme environments making it more reliable with stringent surface insulation resistance and electro-migration criterion from automotive and other high reliability product manufacturers. Crack-free flux residues help to prevent electro-chemical migration caused by moisture entering through the flux residue cracking. In addition, crack-free residues act as a type of conformal coating providing a consideration to assemble without conformal coating use for certain applications.

Experiments were carried out to test the reliability of the flux according to various industry electro-chemical migration and dew test standards using IPC and JIS (Japan Industrial Standard) test boards. The flux residue showed no indication of cracking after pre-conditioning from -30°C to 80°C accelerated thermal cycling for 1,000 cycles followed by testing with no evidence of electro-chemical migration with a variety of board line widths and spacings used on the test boards. Printing, wetting, voiding and reflow tests with components were also carried out to make sure that the developed solder paste was appropriate for high volume manufacturing with results reported.

## Introduction

For automotive and other high reliability applications, the flux in the reflowed solder paste should have reliable insulation resistance even in an atmosphere of high temperature and high humidity. Under extreme environments such as during thermal cycling, cracking can occur in the reflowed solder paste flux residue which can lead to water ingress from high humidity environments in service which can lead to electro-chemical migration reliability issues as shown in Figure 1.

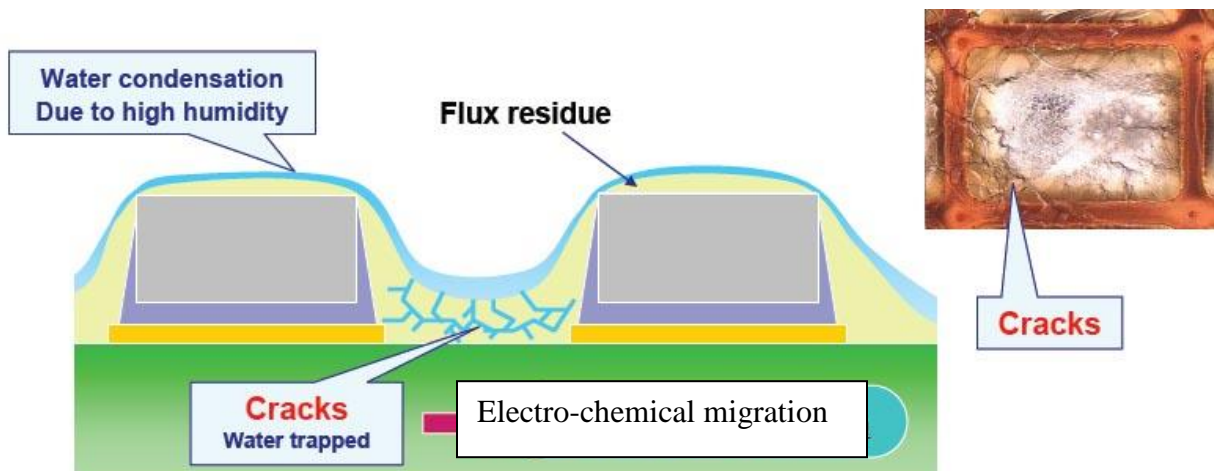

Figure 1: Effect of Flux Cracking on Reliability under High Humidity Conditions

In order to prevent cracking of the reflowed solder paste during thermal cycling, additions were added to the flux to produce a type of 'crack free' flux which would reduce the ingress of water in humidity environments and be more reliable in keeping with stringent industry surface insulation resistance and electro-chemical migration test criterion. The crack-free flux residue would help to prevent electro-chemical migration caused by moisture entering through the flux residue cracking. The crack-free residue could also be act as a type of conformal coating helping to provide an option to assemble without conformal coating use for certain applications. The following sections describe the work done on testing the developed crack-free flux residue solder paste.

## Experimental

### Reliability of Reflowed Flux Residue after Thermal Cycling

The first evaluation was to validate that the developed solder paste did not crack after thermal cycling conditions. Developed crack-free Sn3Ag0.5Cu no-clean Paste A with Type 4 powder size and ROL0 flux type was reflowed and the flux residue subjected to thermal cycling testing from: -30°C to +80°C, for 1,000 cycles with 60 minute cycles.

The company FR4 test board was used with OSP board surface finish. The stencil thickness during printing of the paste was 0.15mm which had laser cut stencil apertures. The stencil apertures were 100% aperture opening to board pad. The reflowed components on the board were 0.5mm pitch QFPs with reflowed board pad dimensions of 1.0mm wide pads and 0.15mm gaps between pads. Reflow of the paste was done in a hot air convection oven in air atmosphere. The reflow profile was preheat for 100 sec from 130°C to 180°C with a peak temperature of 237°C with Time Over 220°C of:45sec as shown in Figure 2.

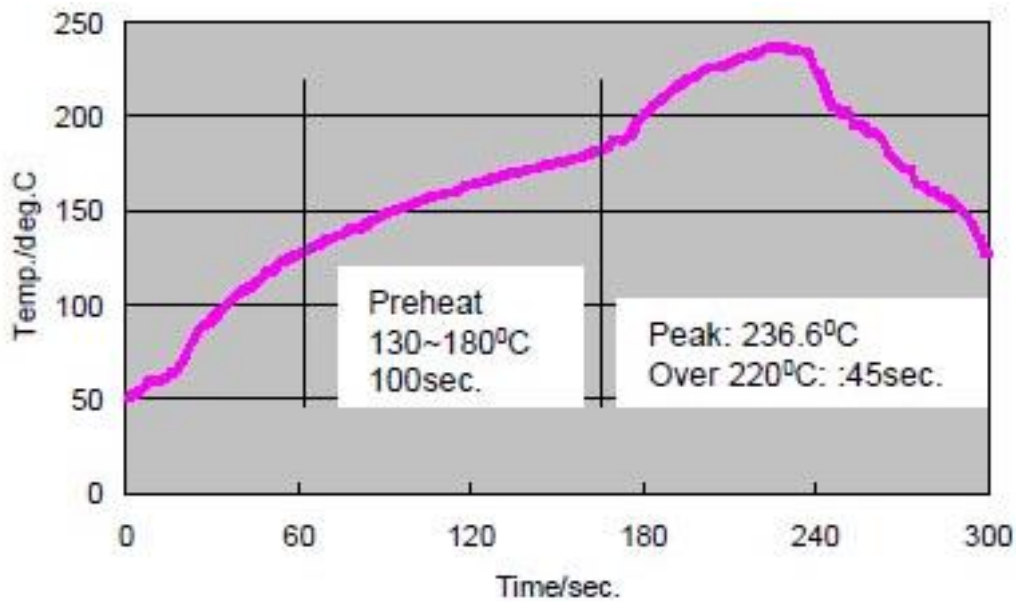
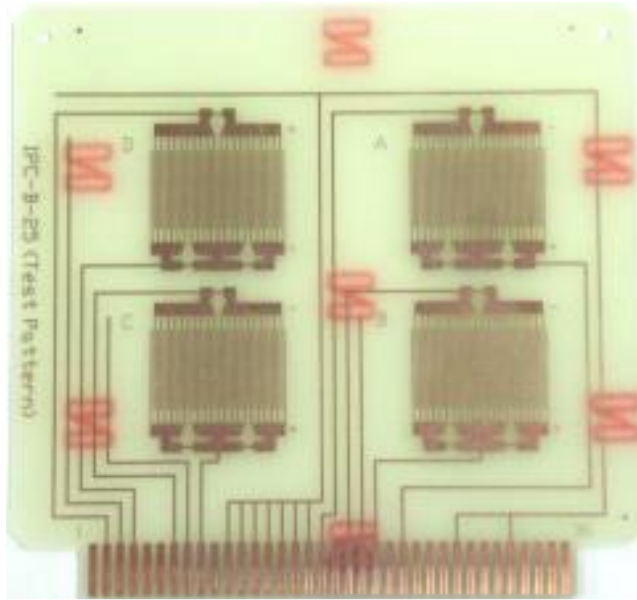

Figure 2: Lead-free reflow profile used

### Reflowed Paste Dew test method (A)

Crack-free soldered Sn3Ag0.5Cu Paste A and conventional solder Sn3Ag0.5Cu Paste B were subjected to the industry dew test method (A) using the IPC-B-25 (E pattern) test board shown in Figure 3 with lines of 0.318mm width and spacing of 0.318mm width.



**Figure 3: IPC-B-25 test board (E pattern)**

The stencil thickness for printing the pastes was 0.1mm thick. The dew test method (A) used a temperature of 10°C~80°C, with humidity: 30%RH~95%RH and cycling was conducted 30 times. The applied voltage during test was 50V with a measurement voltage of 100V. The dew test method (A) temperature and humidity profile is shown in Figure 4. A temperature cycle test of -30°C to ~+80 °C for 1000cycles was conducted prior to the dew test to check the aging effects in the field. It is a severer test condition because the cracking in the residue is promoted more by conducting the temperature cycle test.

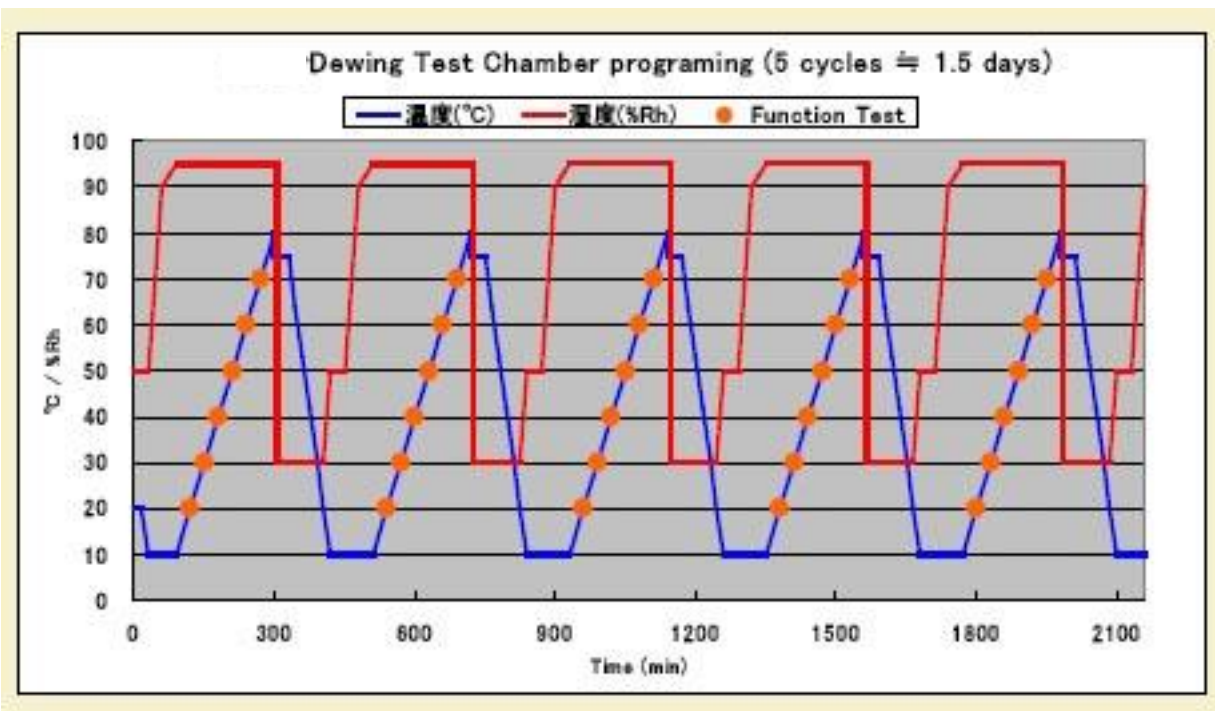
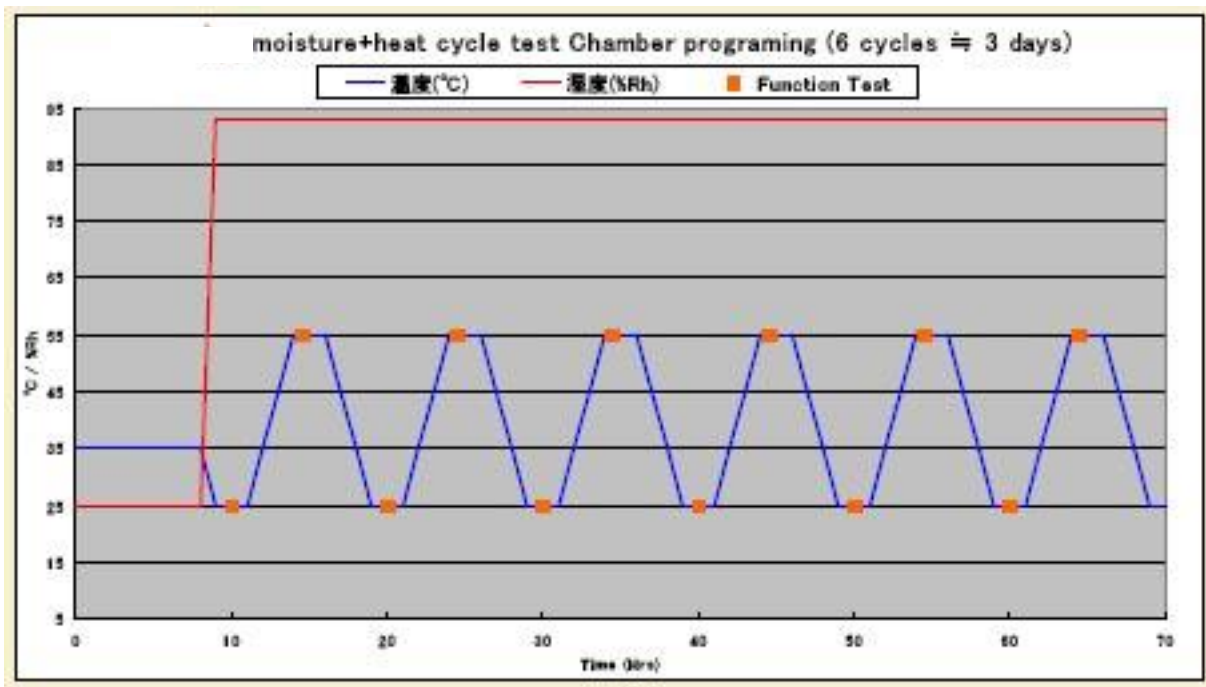

**Figure 4: Dew Test Method (A) Temperature and Humidity Profile**

**Reflowed Paste Dew test method (B)**

Crack-free soldered Sn3Ag0.5Cu Paste A was also subjected to dew test method (B) using the same IPC-B-25 (E pattern) test board as shown in Figure 3.

The stencil thickness for printing the paste was 0.1mm thick. The dew test method (B) followed IEC 60068-2-30 test method which used a temperature of 25°C~55°C, with humidity: 25%RH~93%RH and temperature cycling was conducted 6 times. The applied voltage during the test was 50V with a measurement voltage of 100V. The dew test method (B) temperature and humidity profile in shown in Figure 5.



**Figure 5: Dew Test Method (B) Temperature and Humidity Profile.**

#### **Reflowed Paste High Temperature/Humidity Conventional SIR testing**

Crack-free soldered Sn3Ag0.5Cu Paste A was also subjected to conventional high temperature/humidity SIR testing using the JIS comb pattern test board with lines of 0.318mm width and spacing of 0.318mm width shown in Figure 6. Other test boards with smaller line widths and spacing which included 0.25mm, 0.2mm and 0.175mm were also evaluated with crack-free soldered Paste A.

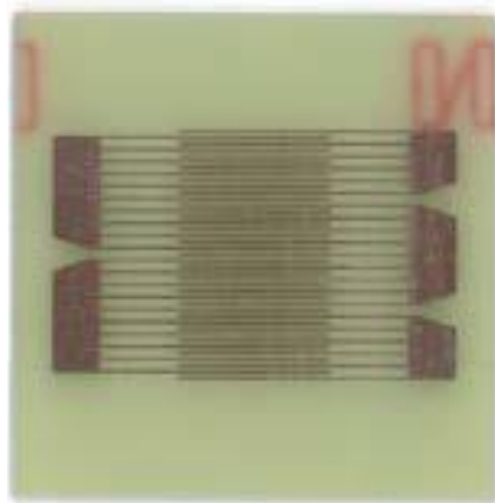

**Figure 6: JIS SIR Test Board with 0.318mm line width and spacing**

The stencil thickness for printing the paste was 0.1mm thick. The conventional high humidity/temperature SIR test used a temperature of 85°C, with humidity:85%RH for 1008 hours. The applied voltage during test was 50V with a measurement voltage of 100V.

### Continual printability paste testing

Crack-Free Paste A was subjected to production printing test using a stencil thickness of 0.15mm with laser cut stencil apertures. The production printer printed the paste using a metal squeegee at an angle of 60°. The print speed was 40 mm/sec on a company test board evaluating 0.4mm pitch QFP pads and a 0.35mm diameter pattern. Paste measurements were conducted using production SPI equipment.

### Paste Viscosity Variation Print Testing

Crack-Free Paste A was subjected to viscosity testing by printing (kneading) solder paste in a sealed up stencil chamber continually for 24 hours to observe any viscosity variation over time. The metal squeegee blade used had an angle of 60° with a squeegee speed of 30mm/sec with a printing stroke of 300mm.

### Solder Fine Pattern Wetting/Reflow Testing

The crack-free Paste A was also subjected to wetting reflow tests using the company test vehicle shown in Figure 7.

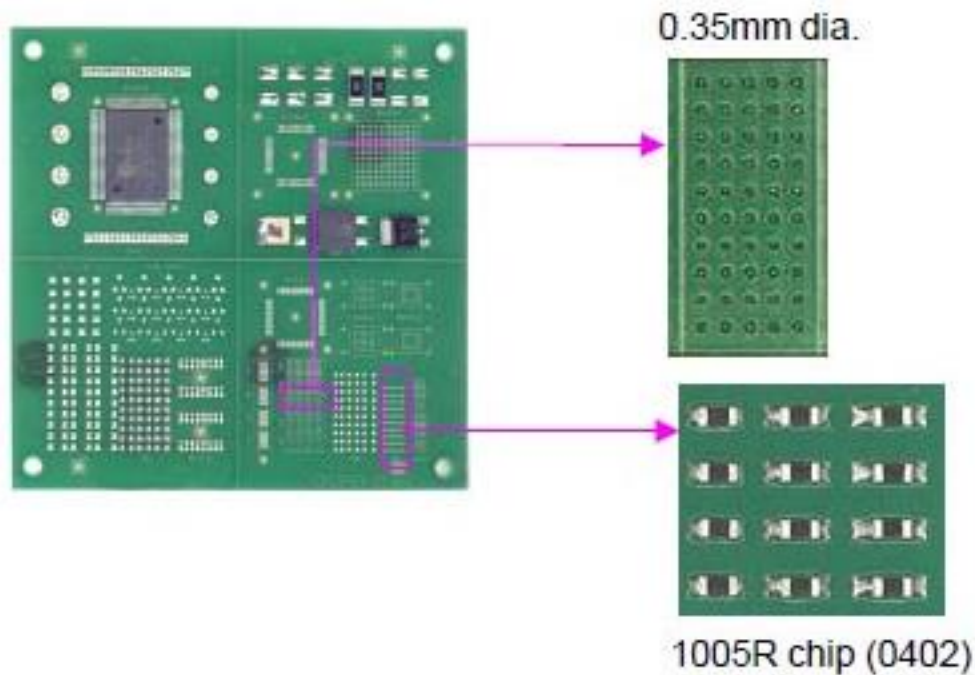

**Figure 7: Company Test Board for Wetting/Reflow Testing**

The FR-4 test board had OSP board surface finish. The stencil thickness for the printed paste was 0.15mm with laser cut stencil apertures having 100% aperture openings to the board pads. The board pad size evaluated had 0.35mm diameter and the component tested was the 1005R chip component with 100% pure tin coating. Reflow was done in a hot air convection oven in air atmosphere with a reflow profile with preheat of 100 sec from 130°C to 180°C with peak temperature of 237°C with time over 220°C of 45sec as shown in Figure 2.

### Voiding/Reflow Testing

Crack-Free Paste A was also subject to voiding/reflow testing using the company test vehicle and components shown in Figure 8.



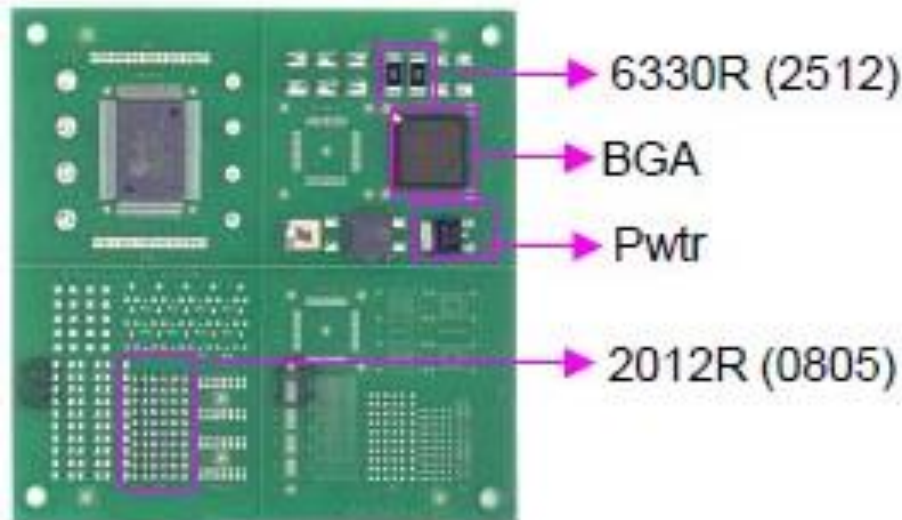

**Figure 8: Company Test Board for Voiding/Reflow Testing**

The FR-4 test board had OSP board surface finish. Paste was printed using a 0.15mm thick laser cut stencil with stencil aperture openings of 100% to the board pad. The components soldered were power transistors, 2012R chips with 100% pure tin coating, 6330R chips with 100% pure tin coating and one type of BGA component with Sn3Ag0.5Cu sphere composition. Reflow was conducted in a hot air convection oven in air atmosphere. The reflow profile used a preheat of 100 sec from 130°C to 180°C with a peak temperature of 237°C with time over 220°C of 45sec as shown in Figure 2.

## Results and Discussion

### Reliability of Reflowed Flux Residue after thermal cycling

The reflowed crack-free Paste A flux residue was thermally cycled from -30°C to +80°C, for 1,000 cycles with 60 minute cycles. There was no evidence of cracking of the flux residue as shown in Figure 9 for 0.5mm pitch QFP components and 1.0mm wide board pads with 0.15mm gap between the pads.

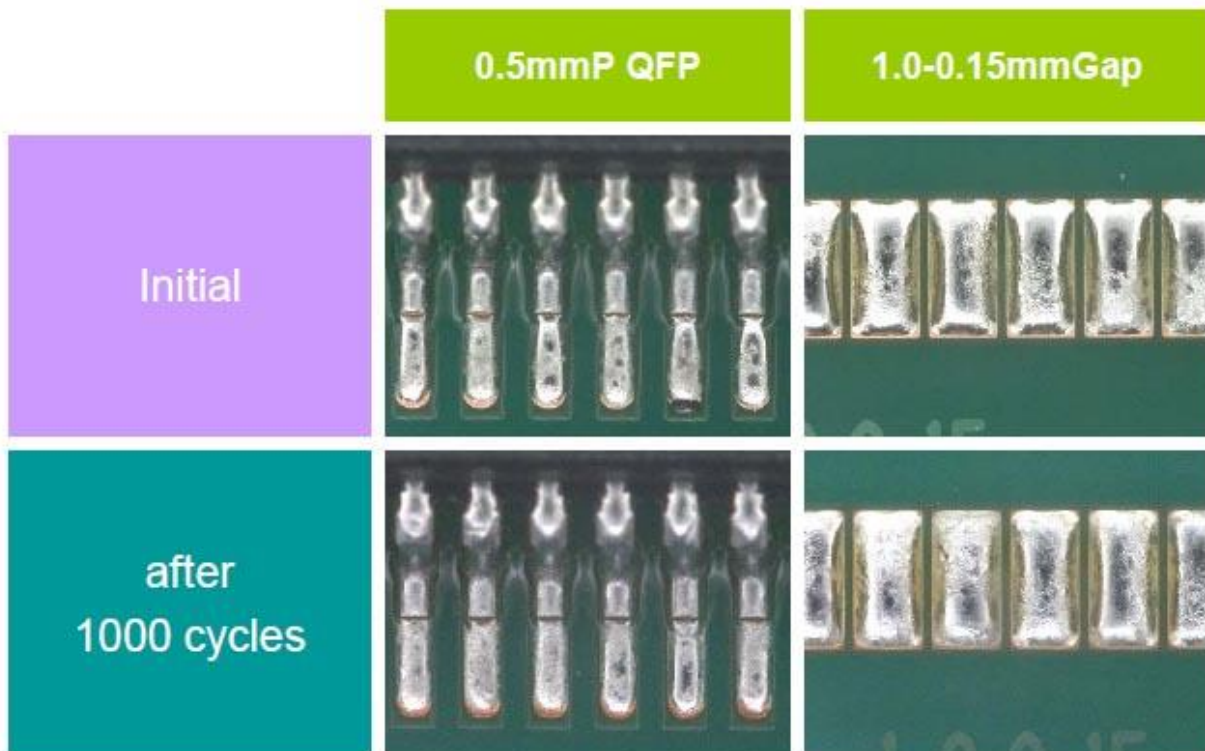

**Figure 9: Cracking test on reflowed crack-free Paste A before and after thermal cycling on soldered 0.5mm pitch QFP component and 1mm wide pads with 0.15mm gaps.**

### Reflowed Paste Dew test method (A)

The crack-free soldered Sn3Ag0.5Cu Paste A and conventional soldered Sn3Ag0.5Cu Paste B were subjected to dew test method (A) using the IPC-B-25 (E pattern) test board. After only 50 hours conventional soldered Paste B showed signs of a short circuit as shown in Figure 10 compared with crack-free Paste B which had no issues during the duration of the test. Dendrites were observed with the conventional Paste B in Figure 11 versus no dendrites or signs of electro-chemical migration for crack-free Paste A as shown in Figure 12.

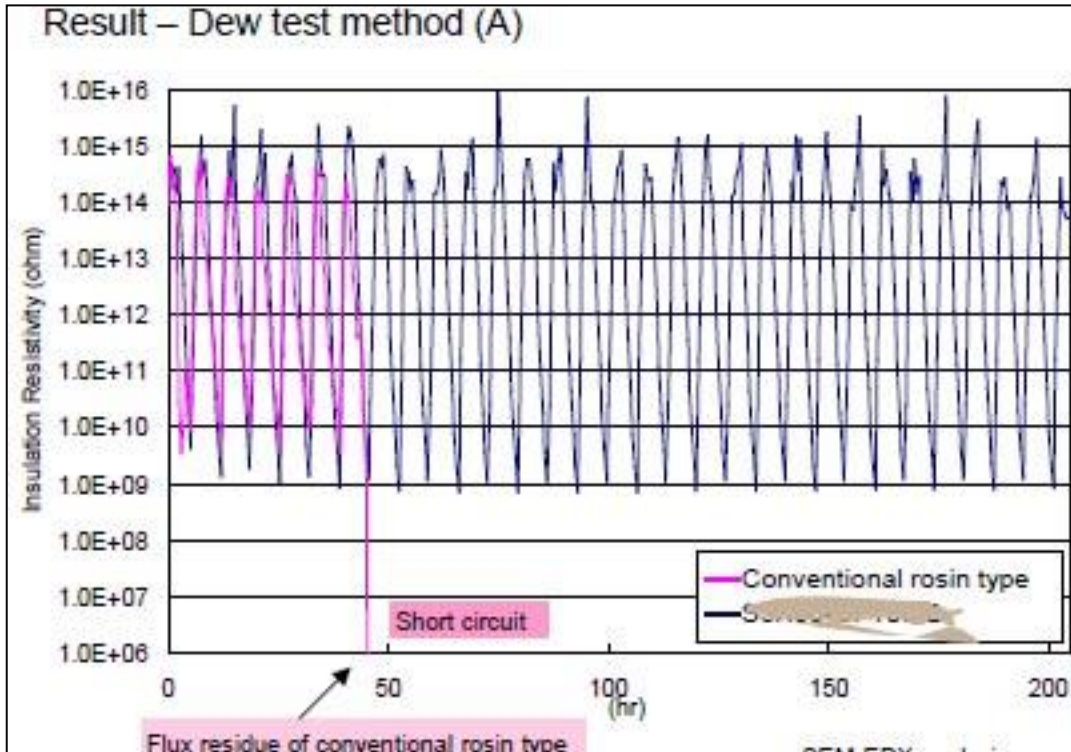

Figure 10: Crack-free reflowed Paste A versus conventional reflowed Paste B during Dew Test method (A) testing

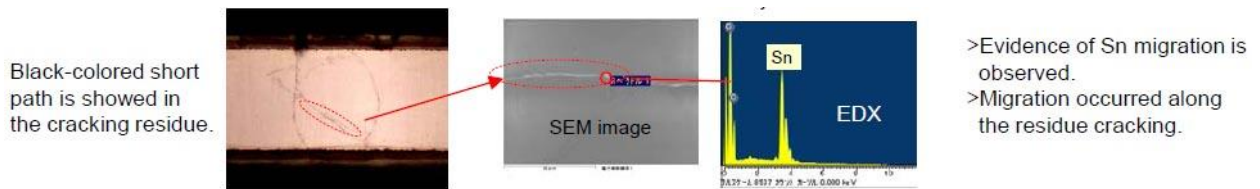
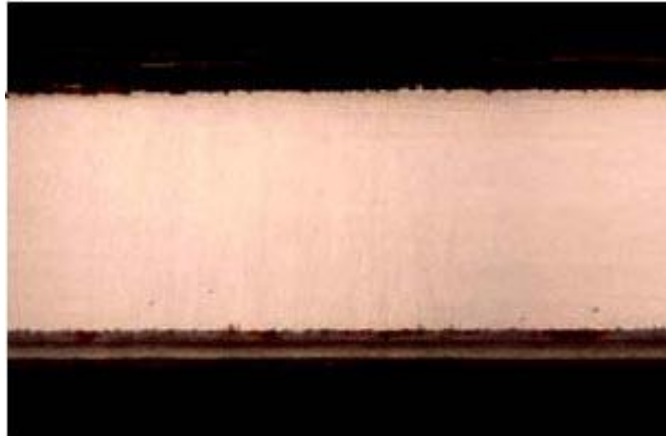

Figure 11: Conventional Reflowed Paste B after Dew test method (A) testing



- > No electro-chemical migration is observed
- > Residue remains crack-free

Figure 12: Crack-free Reflowed Paste A after Dew Test Method (A) testing

### Reflowed Paste Dew test method (B)

Crack-free soldered Sn3Ag0.5Cu Paste A was also subjected to dew test method (B) using the same IPC-B-25 (E pattern) test board following IEC 60068-2-30 test method. There was no evidence of a significant drop in insulation resistance or electro-chemical migration as shown in Figure 13.

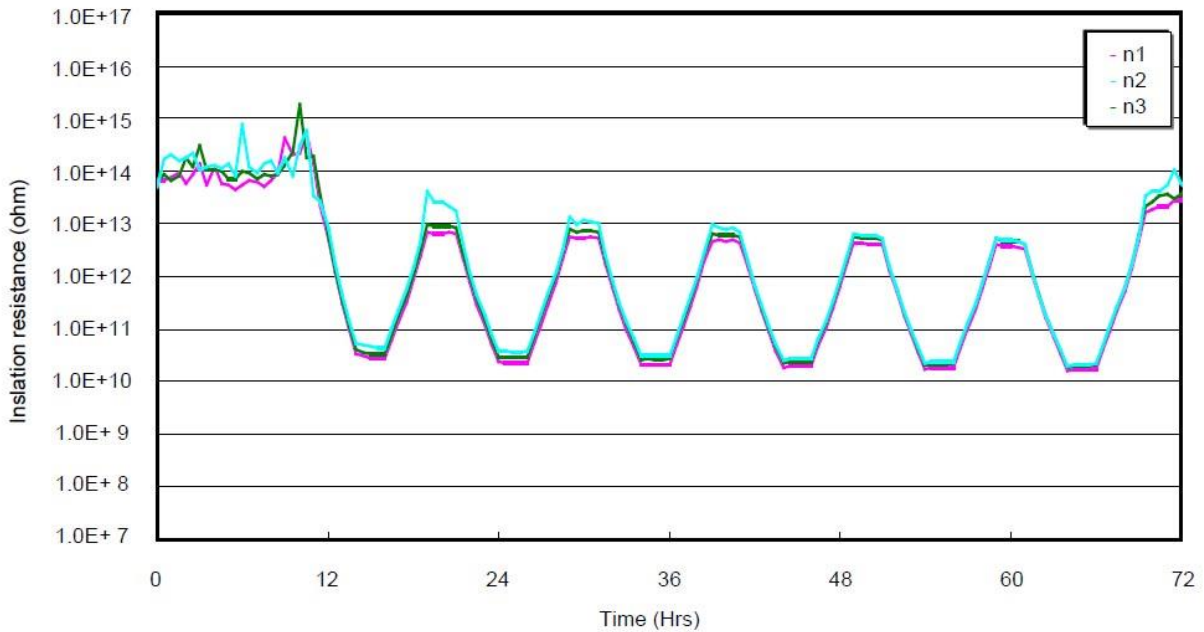

Figure 13: Crack-free reflowed Paste A during Dew test method (B) testing



### Conventional reflowed paste High Temperature/Humidity SIR testing

Crack-free soldered Sn3Ag0.5Cu Paste A was also subjected to conventional high temperature/humidity SIR testing using the JIS comb pattern test board with lines of 0.318mm width and spacing of 0.318mm width and other test boards with smaller line widths and spacing which included 0.25mm, 0.2mm and 0.175mm. The results are shown in Figure 14 which showed no significant drop of insulation or evidence of electro-chemical migration during the tests irrespective of the different line widths and spacings used.

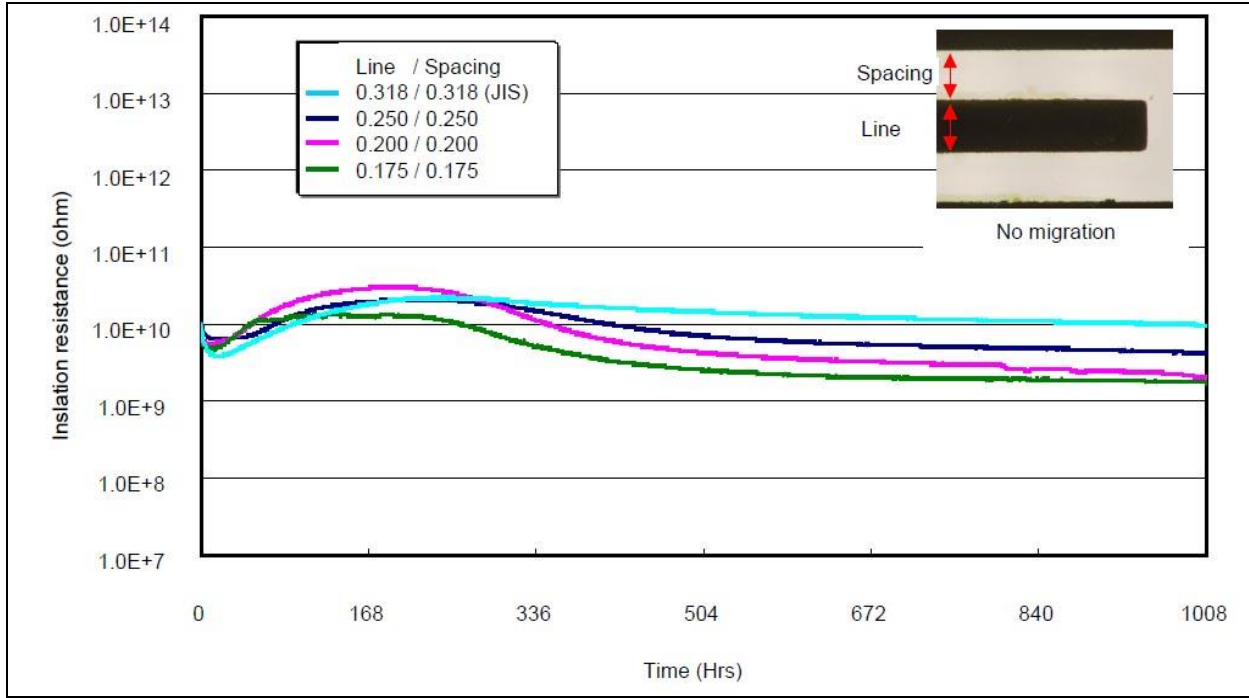

Figure 14: Crack-free reflowed Paste A conventional high temperature/humidity SIR testing data with 0.318mm, 0.25mm, 0.2mm, 0.175mm line widths and spacings.

### Continual printability paste testing

To validate that crack-free Paste A could be used in electronics manufacturing production a series of tests were conducted including continual printability testing. Paste print results were good on 0.35mm diameter board pad patterns and 0.4mm pitch QFP component pads as shown in Figure 15.

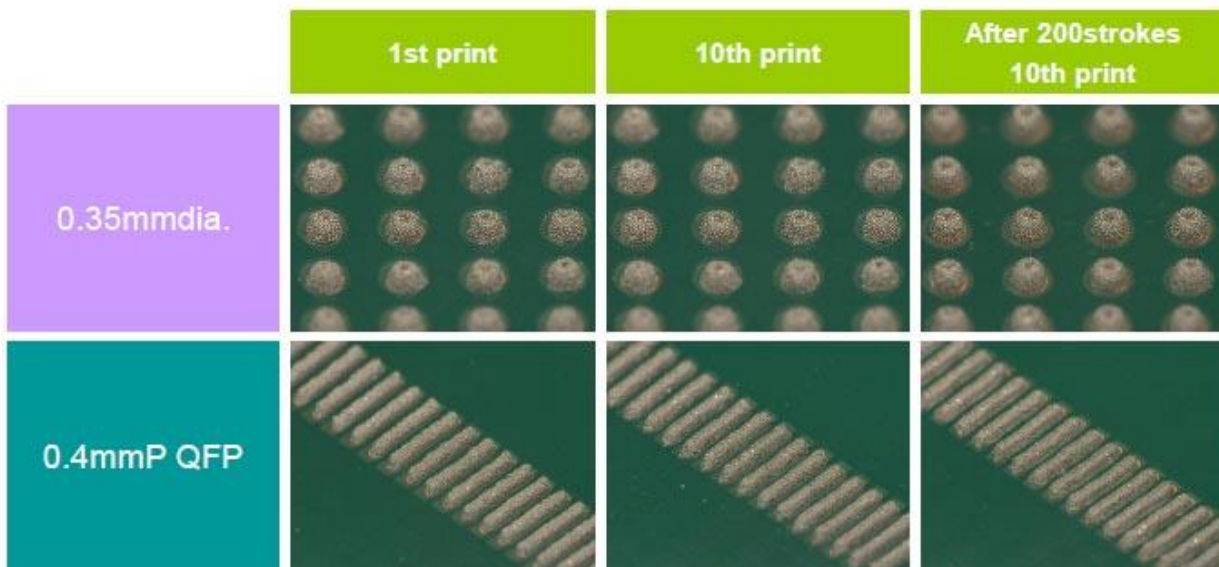

Figure 15: Crack-free Paste A printing results on 0.35mm diameter pads and 0.4mm pitch QFP component pads.

Paste measurements were also conducted using production SPI equipment at these locations showing high paste transfer efficiency after continual printing as indicated in Figure 16.

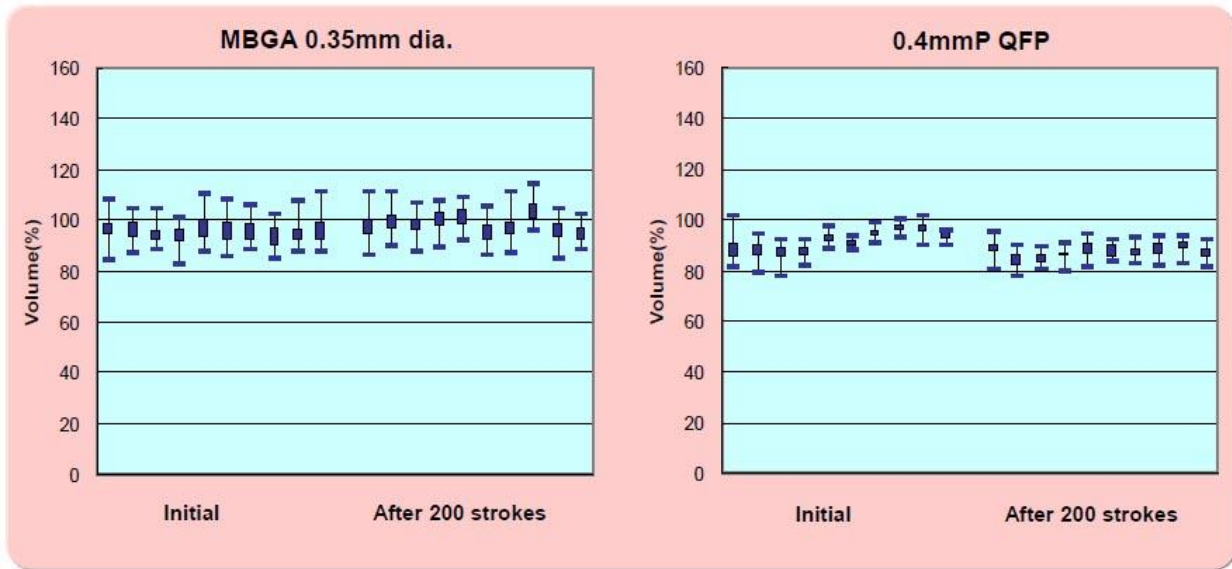

Figure 16: Crack-free Paste A printing SPI data for 0.35mm diameter BGA pads and 0.4mm pitch QFP pads.

#### Paste Viscosity Variation Print Testing

Crack-free Paste A was subjected to viscosity testing by printing (kneading) solder paste in the sealed up stencil chamber continually for 24 hours to observe any viscosity variation over time. As shown in Figure 17, there was an insignificant drop in viscosity over the 24-hour print stroke evaluation which indicates a stable printing performance of the developed solder paste.

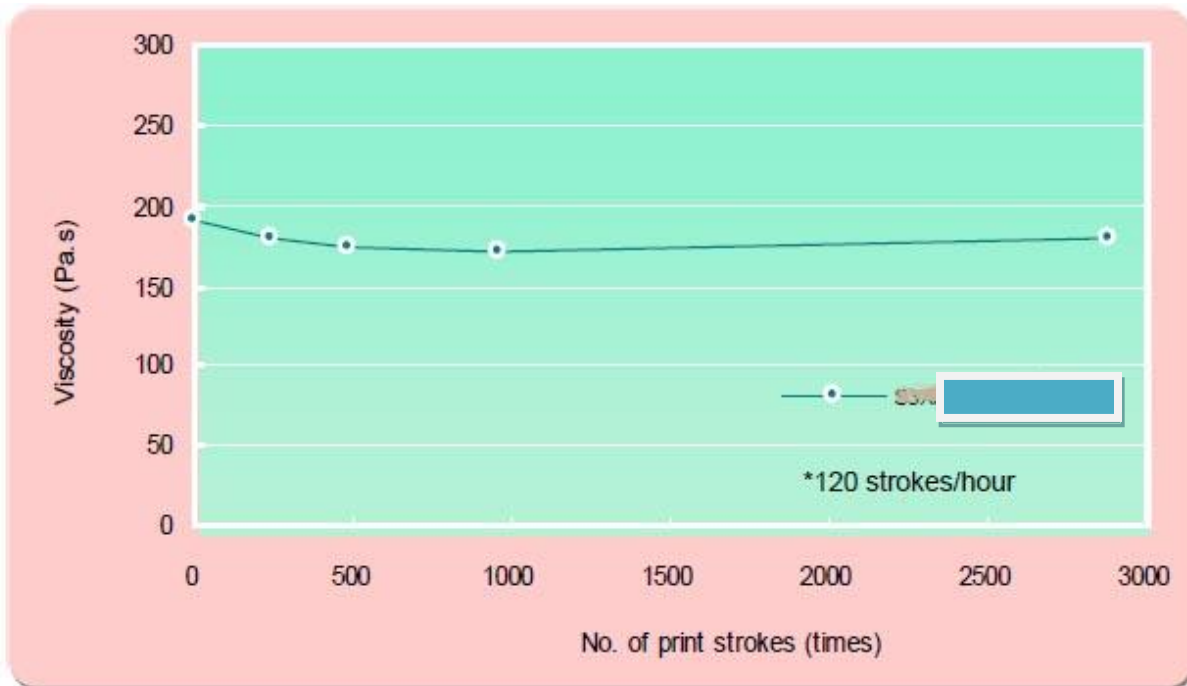
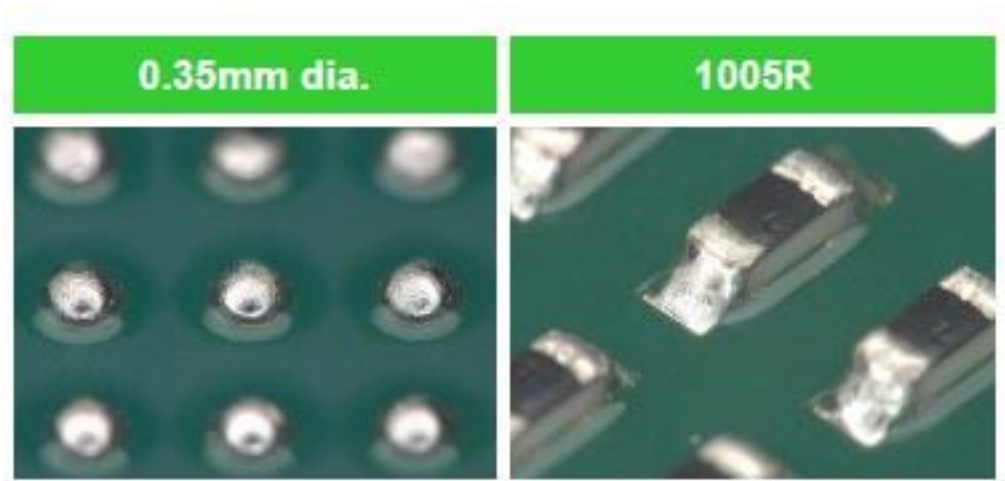

Figure 17: Crack-free Paste A viscosity data over a 24-hour paste printing period

### Solder Fine Pattern Wetting/Reflow Testing

The crack-free Paste A was subjected to wetting/reflow tests using the company test vehicle on 0.35mm diameter board pads and reflowed 1005R chip components in air atmosphere. The results in Figure 18 show good wetting at the 0.35mm diameter board pads and the 1005R soldered chip components.



**Figure 18: Crack-free Paste A wetting/reflow test data for 0.35mm diameter board pads and soldered 1005R soldered chip components.**

### Voiding/Reflow Testing

Crack-free Paste A was evaluated in additional voiding/reflow tests using the company test vehicle and soldered components consisting of power transistors, 2012R chips, 6330R chips and a particular type of BGA component reflowed in air atmosphere. Results showed good wetting and low incidence of voiding as shown in Figure 19.

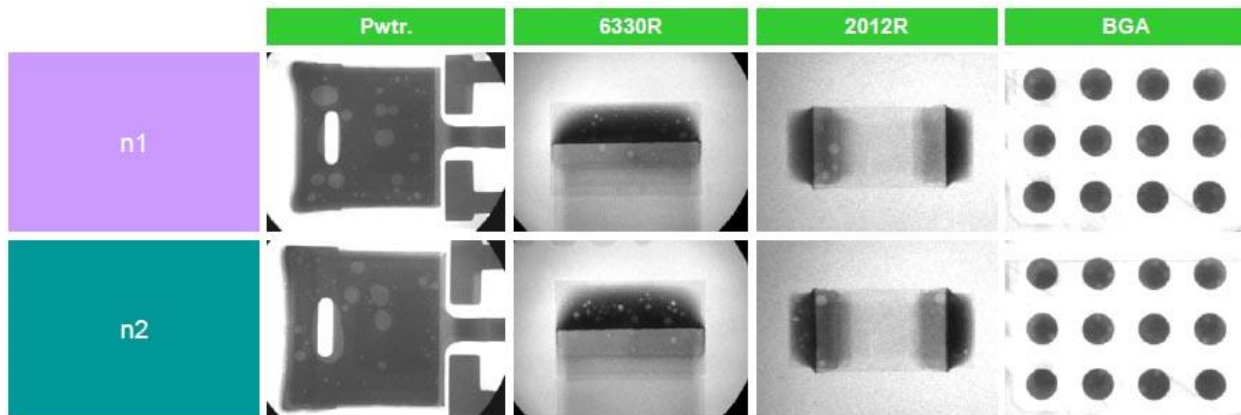

**Figure 19: Crack-free Paste A reflow/voiding test data for soldered Power transistor, 6330R chip, 2012R chip and BGA components.**

### Typical Crack-Free Solder Paste Applications in Industry

Based on the evaluation results above, the developed Paste A is being evaluated and used in the industry. One area has been in automotive applications with Table 1 showing typical applications in the automotive industry. Some of these applications have now not required the use of conformal coating which has resulted in additional cost savings and reduced production/processing times.

**Table 1: Typical applications in industry such as automotive for Crack-free Paste A.**

Unit	Environment	Application of Crack-free Paste A	Assembly without conformal coating
Power train control	Cabin	Yes	Yes
	Engine compartment	Yes	Yes
	On engine	Yes	-
Air bag control	Cabin	Yes	-
Brake control	Engine compartment	Yes	-
Body control	Cabin	Yes	Yes
	Engine compartment	Yes	-
Security system	Cabin	Yes	Yes
Audio / Navigation	Cabin	Yes	Yes

**Conclusions**

A lead-free solder paste was developed which was resistant to cracking during thermal cycling. This resistance to cracking was shown to provide reliable insulation resistance even under conditions of high temperature and high humidity using various industry test methods which helped to prevent electro-chemical migration caused by moisture entering through the flux residue cracks. The crack-free residue acted as a type of conformal coating providing a consideration to assemble without conformal coating use for certain applications.

Printing, wetting, voiding and reflow tests with components using the developed paste indicated it could be used in high volume electronics manufacturing which has been validated in production.

# Improved Flux Reliability of Lead-Free Solder Alloy Solder Paste Formulated with Rosin and Anti-crack Resin for Automotive and Other High Reliability Applications

Shantanu Joshi<sup>1</sup>, Jasbir Bath<sup>1</sup>, Mitsuyasu Furusawa<sup>2</sup>, Junichi Aoki<sup>2</sup>,  
Roberto Garcia<sup>1</sup>, Manabu Itoh<sup>2</sup>

<sup>1</sup>Koki Solder America Inc., USA, <sup>2</sup>Koki Company Ltd., Japan.

[shantanu@kokiamerica.com](mailto:shantanu@kokiamerica.com)



## **Agenda/ Outline**

- **Introduction**
- **Experimental Procedure**
- **Results and Discussion**
- **Conclusions**

## Introduction

- For automotive and other high reliability applications, the flux in the reflowed solder paste should have reliable insulation resistance even in an atmosphere of high temperature and high humidity.
- During thermal cycling, cracking can occur in reflowed solder paste flux residue which can lead to water ingress from high humidity environments in service which can lead to electro-chemical migration reliability issues.

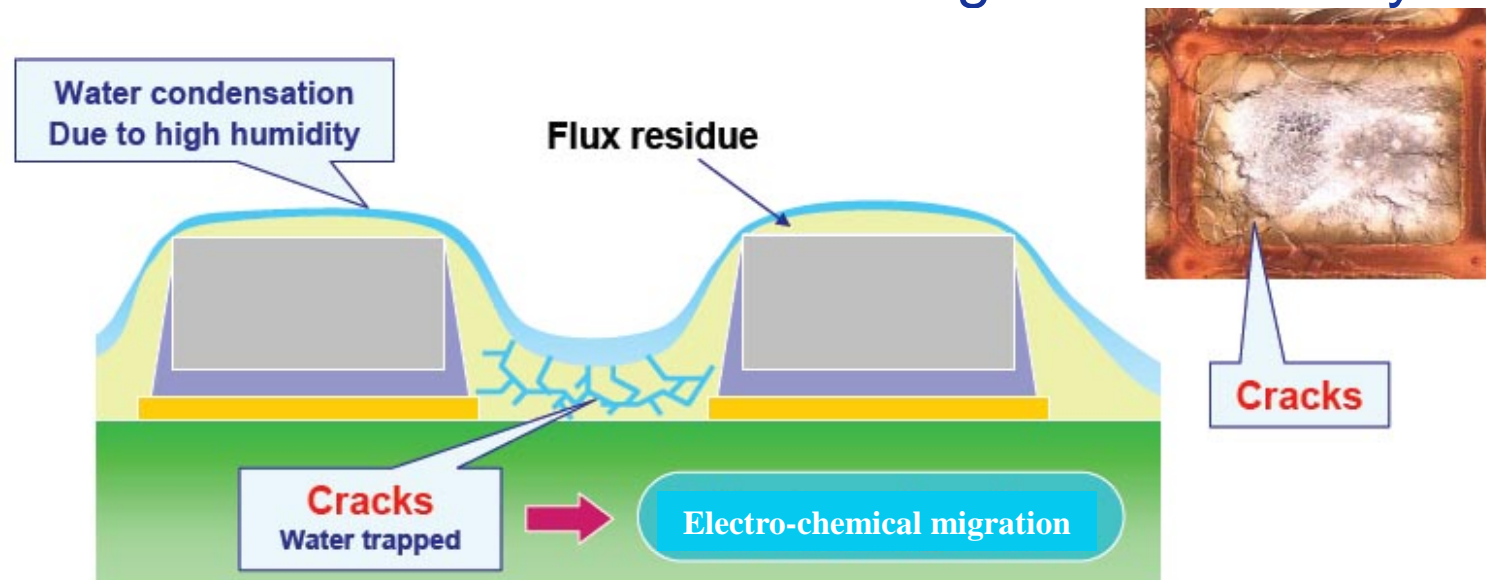

## Introduction (Cont.)

- To prevent cracking of reflowed solder paste during thermal cycling, additions were added to the flux to produce a type of 'crack free' flux which would reduce ingress of water and be more reliable in terms of SIR and electro-chemical migration testing.
- The crack-free residue could also be act as a type of conformal coating helping to provide an option to assemble without conformal coating use for certain applications.
- Work discusses testing developed crack-free flux residue solder paste.

## **Experimental Procedure**

- **1. Reliability of Reflowed Flux Residue after Thermal Cycling**
- **2. Reflowed Paste Dew test method (A)**
- **3. Reflowed Paste Dew test method (B)**
- **4. Reflowed Paste High Temperature/Humidity Conventional SIR testing**
- **5. Continual printability paste testing**
- **6. Paste Viscosity Variation Print Testing**
- **7. Solder Fine Pattern Wetting/Reflow Testing**
- **8. Voiding/Reflow Testing**



## Reliability of Reflowed Flux Residue after Thermal Cycling

- Developed crack-free Sn3Ag0.5Cu no-clean Paste A reflowed and flux residue subjected to thermal cycling from: -30°C to +80°C, for 1,000 cycles, 60 min. cycles.
- The company FR4 test board was used (OSP board surface finish).
- Reflowed components on board were 0.5mm pitch QFPs with reflowed board pad dimensions of 1.0mm wide pads and 0.15mm gaps between pads.
- Reflow of paste in a hot air convection reflow oven with peak temperature of 237°C and Time Over 220°C of 45sec.



## Reflowed Paste Dew test method (A)

- Crack-free soldered Sn3Ag0.5Cu Paste A and conventional solder Sn3Ag0.5Cu Paste B subjected to industry dew test method (A) using IPC-B-25 (E pattern) test board with lines of 0.318mm width and spacing of 0.318mm width.
- Dew test method (A): Temp.:10°C~80°C, Humidity: 30%RH~95%RH, 30 cycles.
- Temperature cycle test from -30°C to ~+80 °C,1000 cycles prior to dew test.

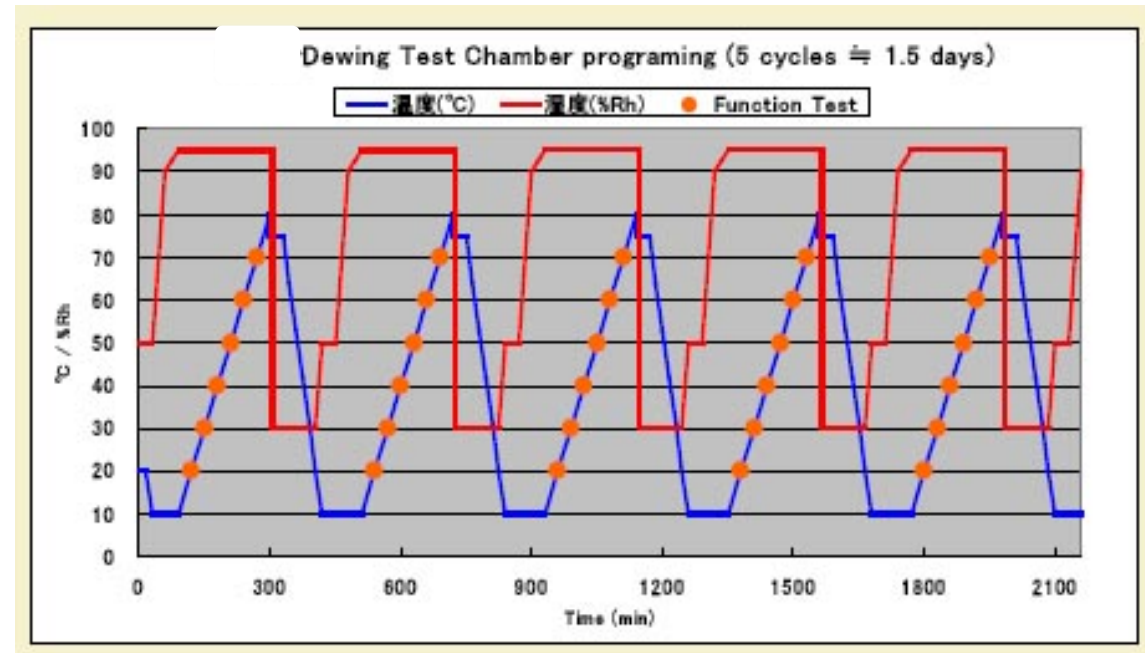
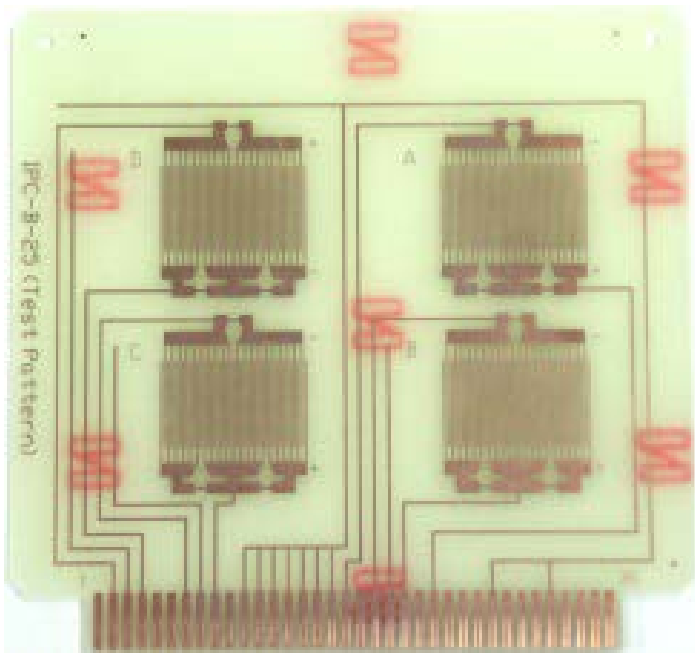

## Reflowed Paste Dew test method (B)

- Crack-free soldered Sn3Ag0.5Cu Paste A subjected to dew test method (B) using same IPC-B-25 (E pattern) test board.
- Dew test method (B) followed IEC 60068-2-30 test method: Temperature: 25°C~55°C; Humidity: 25%RH~93%RH, 6 cycles.

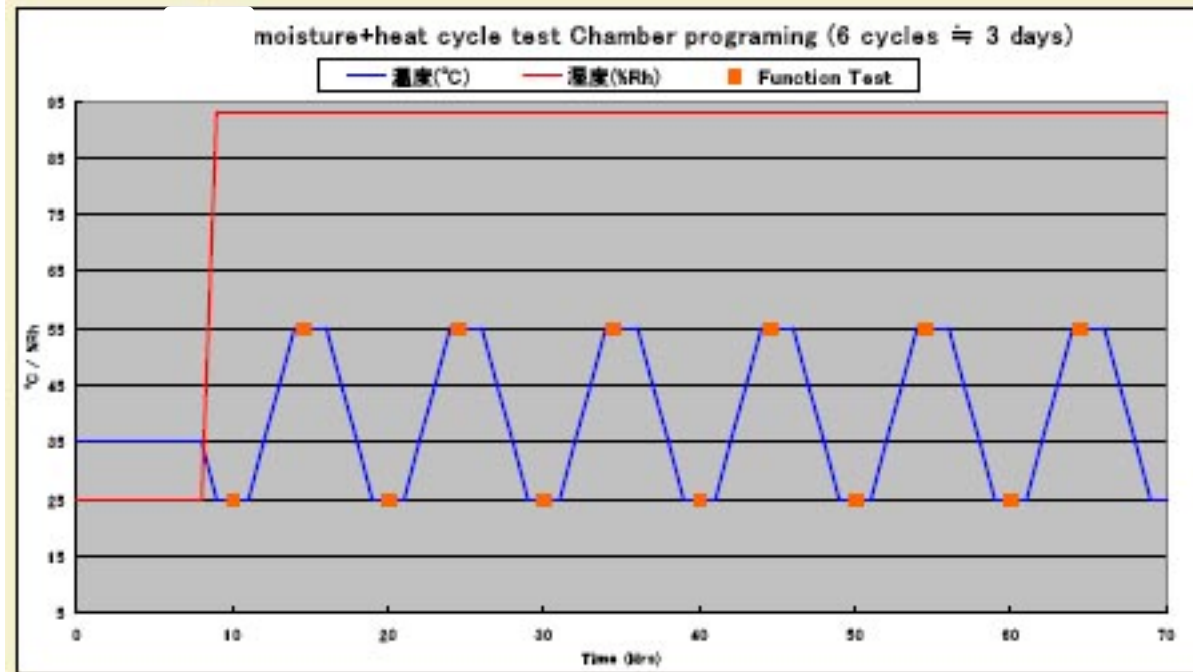

## Reflowed Paste High Temperature/Humidity Conventional SIR testing

- Crack-free soldered Sn3Ag0.5Cu Paste A subjected to conventional high temperature/humidity SIR testing using JIS comb pattern test board with lines of 0.318mm width and spacing of 0.318mm width

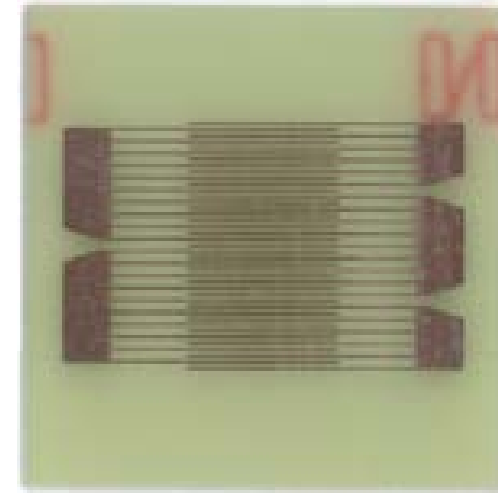

- Other test boards with smaller line widths and spacing included 0.25mm, 0.2mm and 0.175mm also evaluated with crack-free soldered Paste A
- Conventional high humidity/temperature SIR test used temperature of 85°C, with humidity:85%RH for 1008 hours.

## **Continual printability paste testing**

- Crack-Free Paste A subjected to production printing test using stencil thickness of 0.15mm (6mils) with laser cut stencil apertures.
- Print speed was 40 mm/sec on company test board evaluating 0.4mm pitch QFP pads and 0.35mm diameter pattern.
- Paste measurements conducted using production SPI equipment.



## **Paste Viscosity Variation Print Testing**

- Crack-Free Paste A subjected to viscosity testing by printing (kneading) solder paste in a sealed up stencil chamber continually for 24 hours.
- Metal squeegee blade had squeegee speed of 30mm/sec with printing stroke of 300mm.



## Solder Fine Pattern Wetting/Reflow Testing

- Crack-free Paste A subjected to wetting reflow tests using company FR-4 test vehicle with OSP board surface finish.
- Board pad sizes evaluated were 0.35mm diameter and the component tested was 1005R chip component with 100% pure tin coating.
- Reflow done in hot air convection reflow oven with a reflow peak temperature of 237°C with time over 220°C of 45sec.

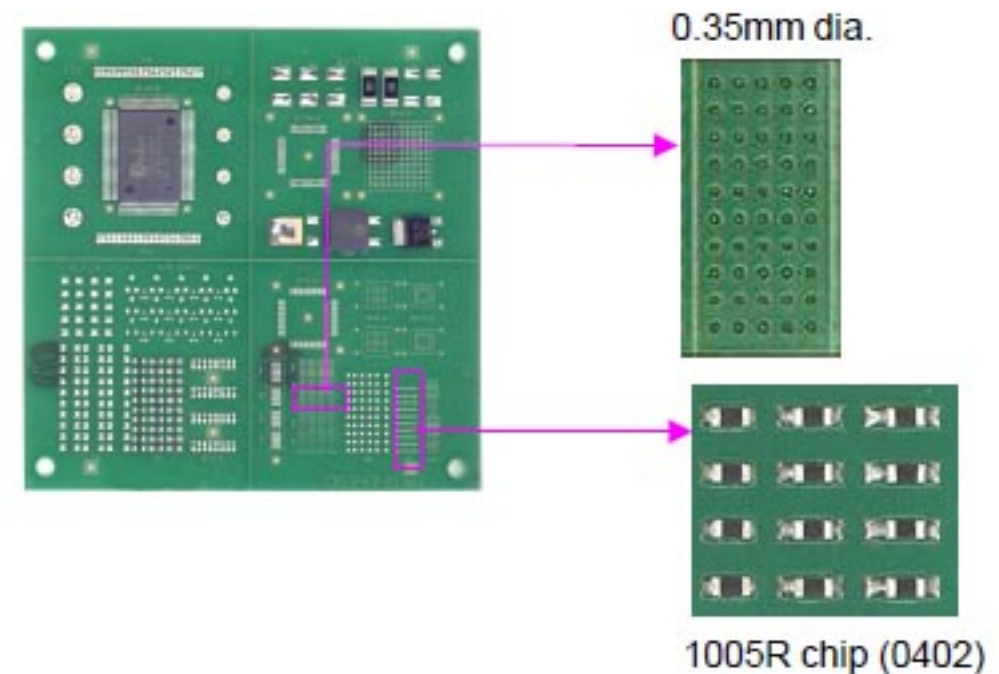

## Voiding/Reflow Testing

- Crack-Free Paste A also subjected to voiding/reflow testing using company FR-4 test vehicle (OSP board finish) and components.
- Components soldered were power transistors, 2012R chips with 100% pure tin coating, 6330R chips with 100% pure tin coating and BGA component (Sn3Ag0.5Cu sphere composition).
- Reflow conducted in a hot air convection oven with reflow profile peak temperature of 237°C with time over 220°C of 45sec.

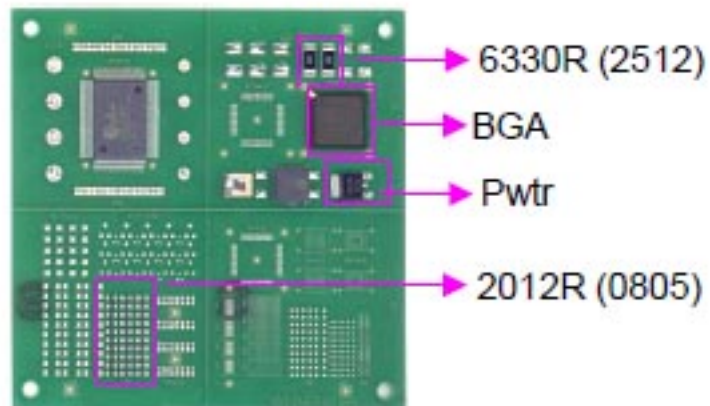

## **Results and Discussion**

- **1. Reliability of Reflowed Flux Residue after Thermal Cycling**
- **2. Reflowed Paste Dew test method (A)**
- **3. Reflowed Paste Dew test method (B)**
- **4. Reflowed Paste High Temperature/Humidity Conventional SIR testing**
- **5. Continual printability paste testing**
- **6. Paste Viscosity Variation Print Testing**
- **7. Solder Fine Pattern Wetting/Reflow Testing**
- **8. Voiding/Reflow Testing**



## Reliability of Reflowed Flux Residue after Thermal Cycling

- Reflowed crack-free Paste A flux residue thermally cycled from -30°C to +80°C.

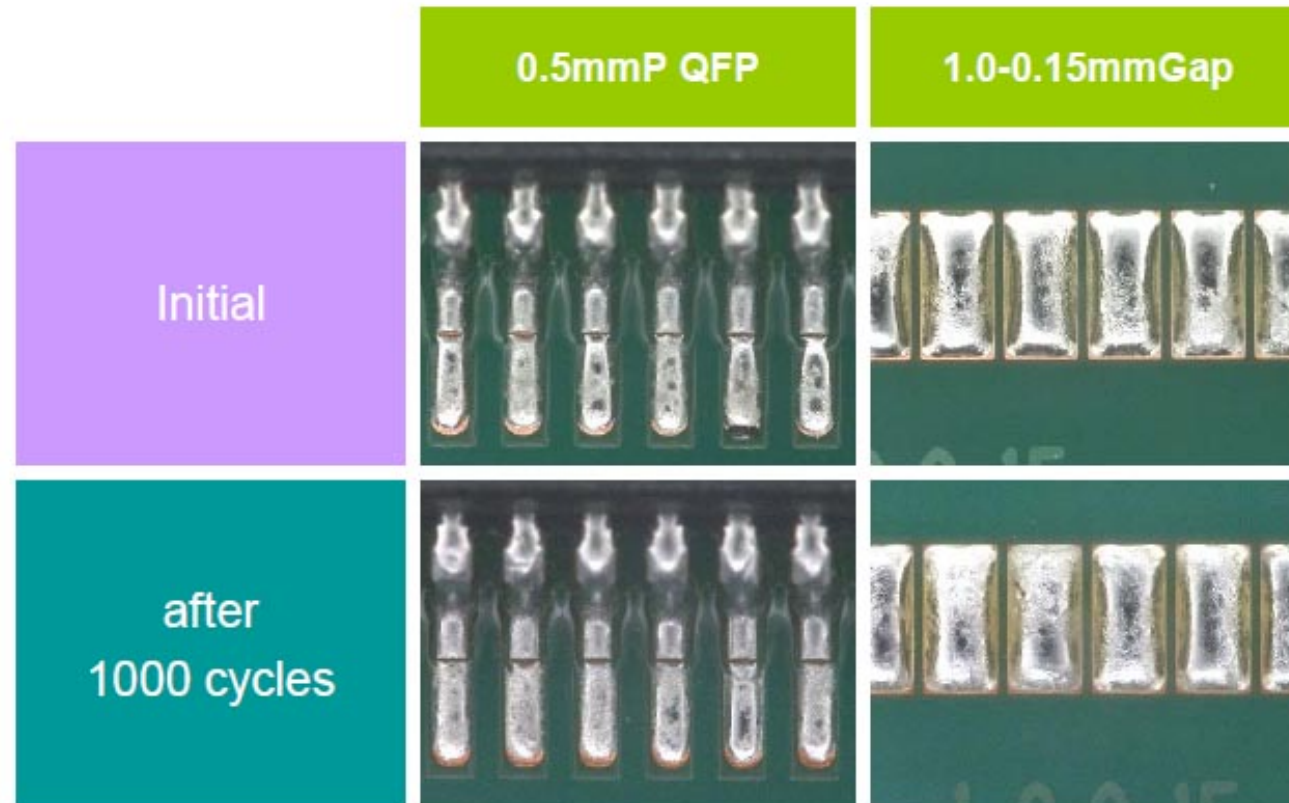

- No evidence of cracking of the flux residue.

## Reflowed Paste Dew test method (A)

- Crack-free soldered Sn3Ag0.5Cu Paste A and conventional soldered Sn3Ag0.5Cu Paste B subjected to dew test method (A).
- After only 50 hours conventional soldered Paste B had signs of a short circuit compared with crack-free Paste A which had no issues during duration of test.

Result – Dew test method (A)

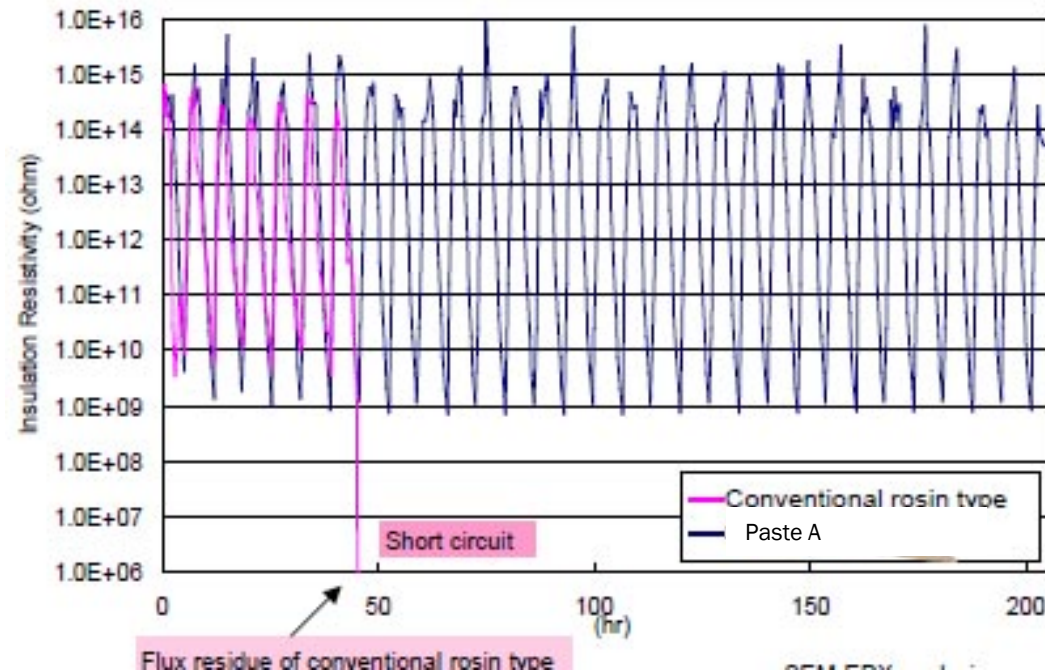



## Reflowed Paste Dew test method (A) (Cont.)

- Dendrites were observed with the conventional Paste B versus no dendrites or signs of electro-chemical migration for crack-free Paste A.

Black-colored short path is showed in the cracking residue.

**Conventional Paste B**

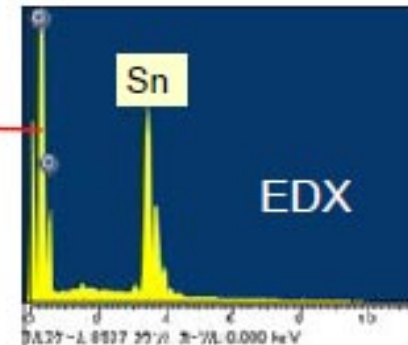
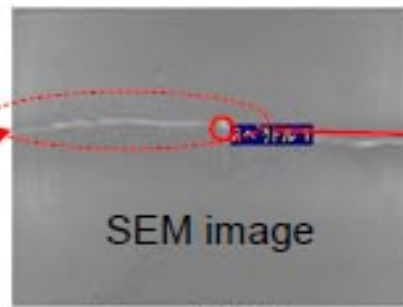
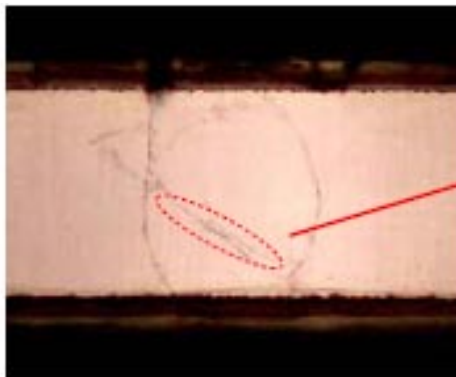

- >Evidence of Sn migration is observed.
- >Migration occurred along the residue cracking.

**Crack-free Paste A**

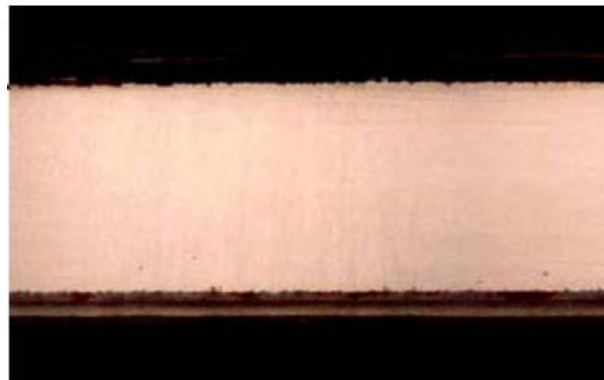

No electro-chemical migration is observed  
Residue remains crack-free

## Reflowed Paste Dew test method (B)

- Crack-free soldered Sn3Ag0.5Cu Paste A subjected to dew test method (B)

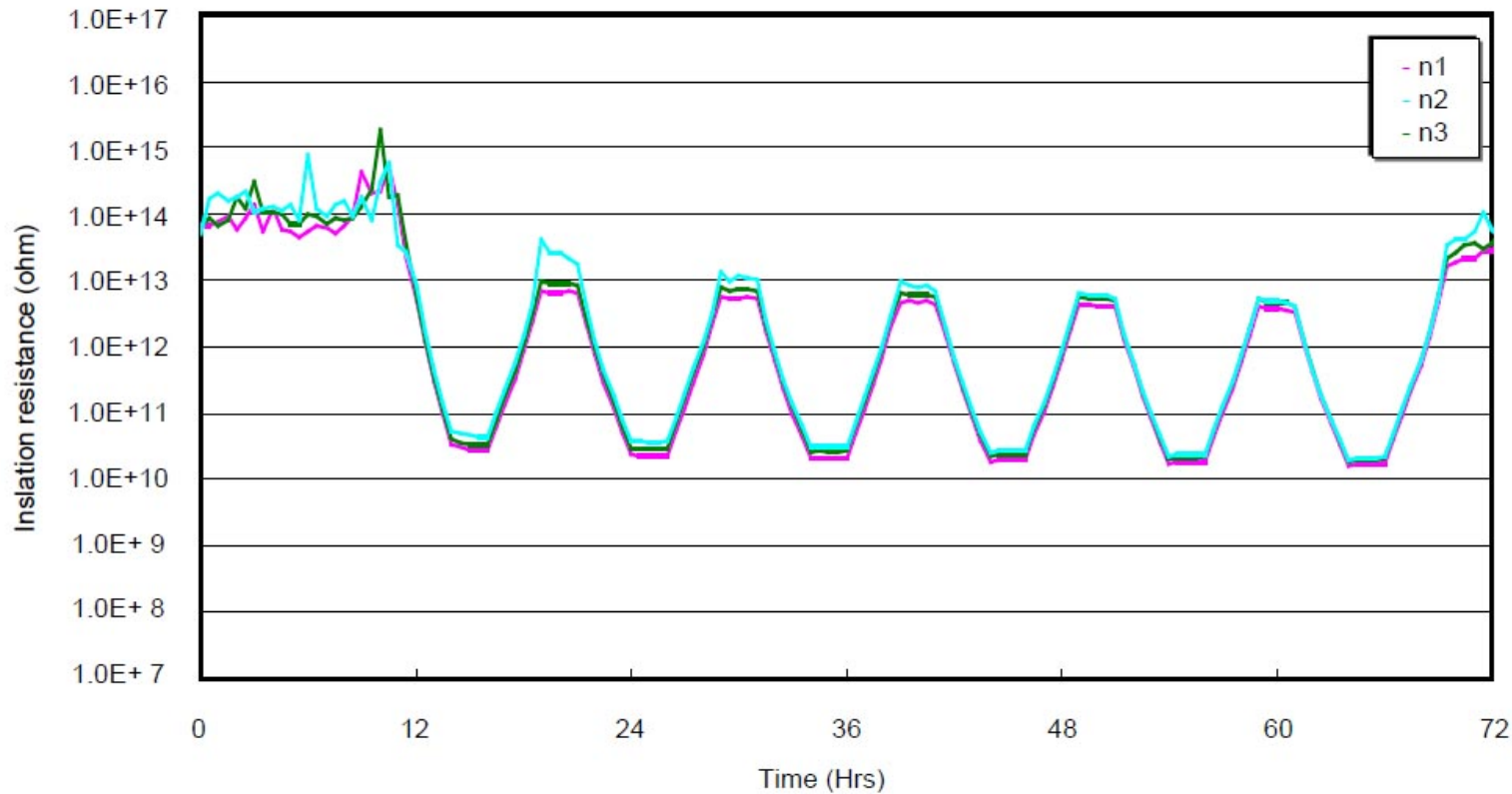

- There was no evidence of a significant drop in insulation resistance or electro-chemical migration.

# Reflowed Paste High Temp./Humidity Conventional SIR testing

- Crack-free soldered Sn3Ag0.5Cu Paste A showed no significant drop of insulation resistance or evidence of electro-chemical migration during the tests irrespective of different line widths and spacings used.

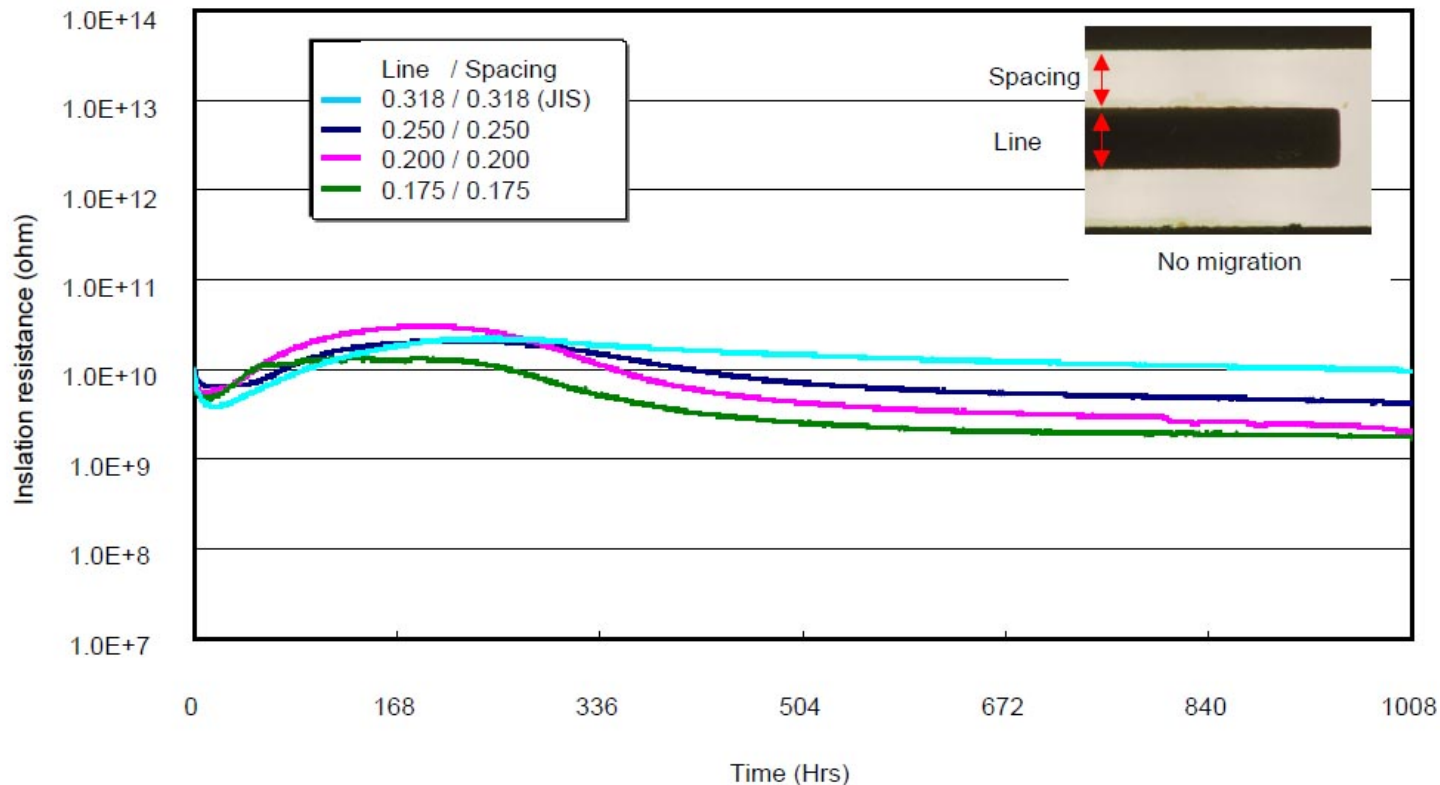



## Continual printability paste testing

- Crack-free Paste A print results were good on 0.35mm diameter board pad patterns and 0.4mm pitch QFP component pads.

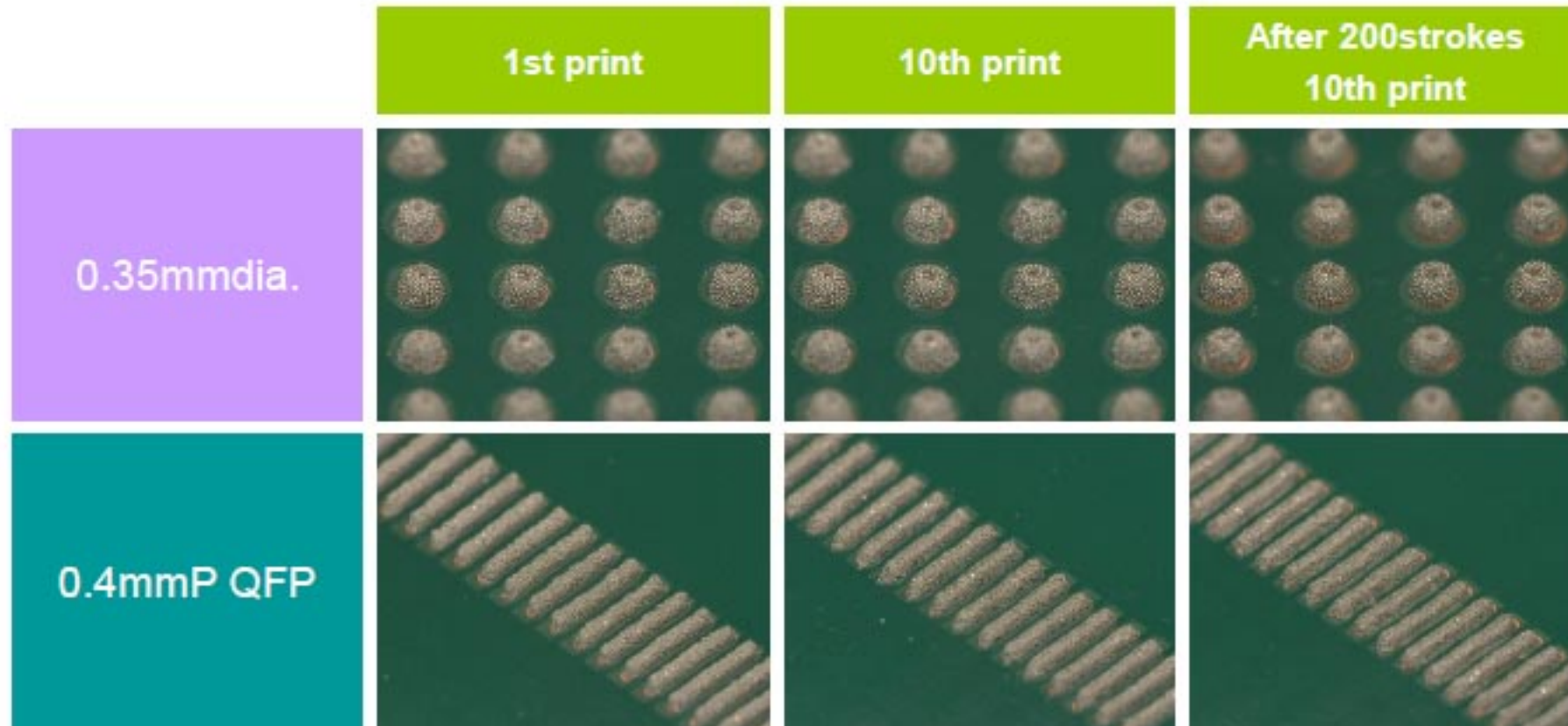

## Continual printability paste testing (Cont.)

- Paste A measurements conducted using production SPI equipment at these locations showed high paste transfer efficiency after continual printing.

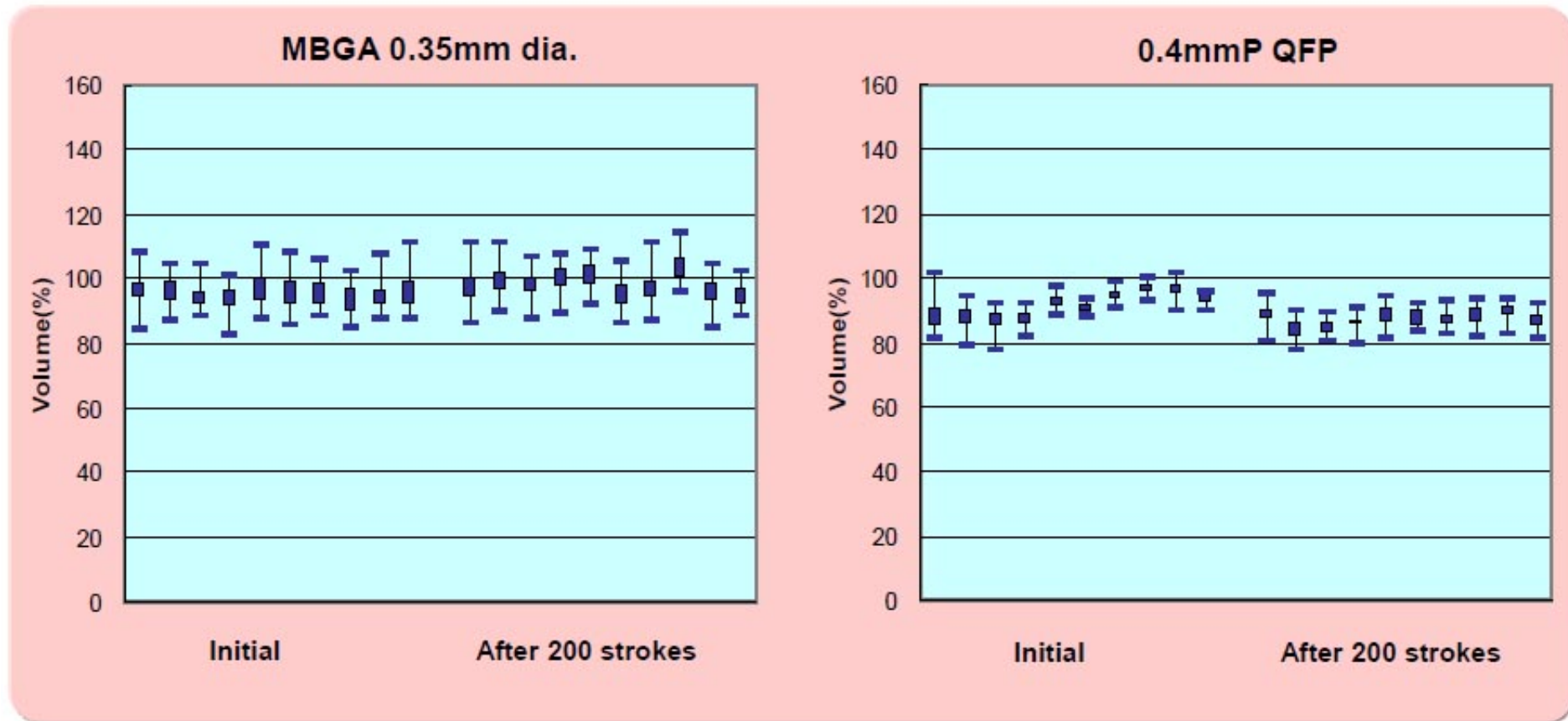



## Paste Viscosity Variation Print Testing

- Crack-free Paste A showed insignificant drop in viscosity over 24 hour print stroke evaluation with stable printing performance.

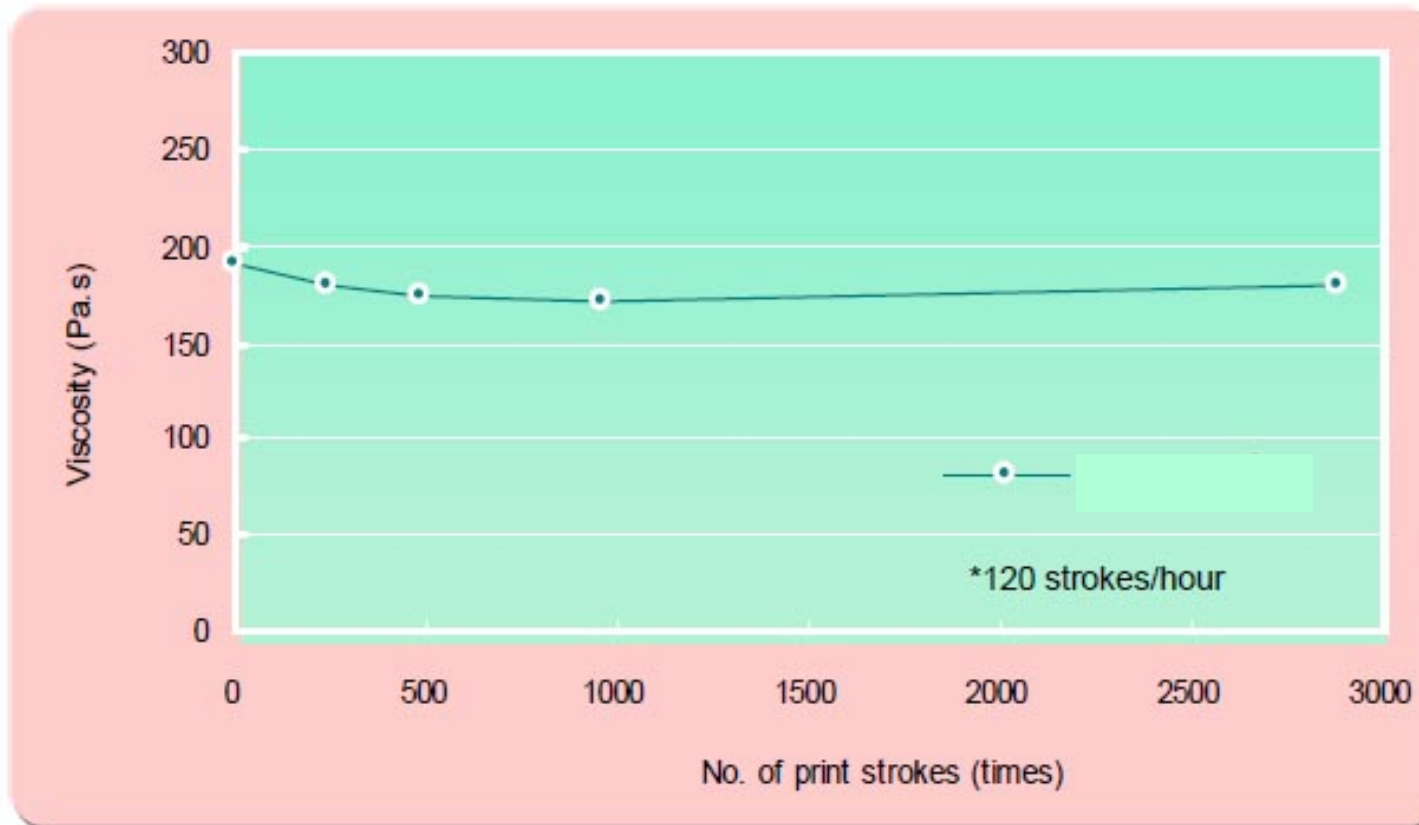

## Solder Fine Pattern Wetting/Reflow Testing

- Crack-free Paste A showed good wetting at 0.35mm diameter board pads and 1005R soldered chip components.



## Voiding/Reflow Testing

- Crack-free Paste A evaluated in additional voiding/reflow tests showed good wetting and low incidence of voiding.

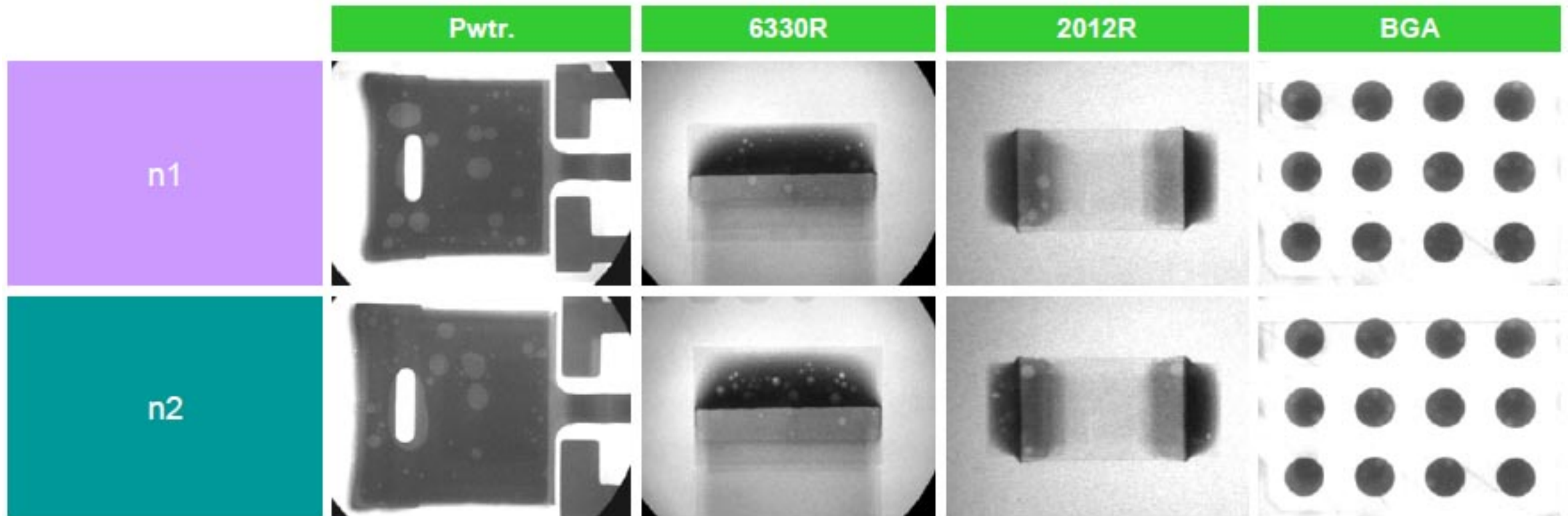

## Typical Crack-Free Solder Paste Applications in Industry

- Based on results, developed Paste A is being evaluated and used in industry.
- Table shows typical applications in automotive industry.

Unit	Environment	Application of Crack-free Paste A	Assembly without conformal coating
Power train control	Cabin	Yes	Yes
	Engine compartment	Yes	Yes
	On engine	Yes	-
Air bag control	Cabin	Yes	-
Brake control	Engine compartment	Yes	-
Body control	Cabin	Yes	Yes
	Engine compartment	Yes	-
Security system	Cabin	Yes	Yes
Audio / Navigation	Cabin	Yes	Yes

- Some of these applications have not required the use of conformal coating resulting in additional cost savings and reduced production/processing times.



## Conclusions

- Lead-free solder paste developed with resistance to cracking during thermal cycling.
- Flux residue crack resistance provided reliable insulation resistance even under conditions of high temp. and humidity using various industry test methods to prevent electro-chemical migration caused by moisture entering flux residue cracks.
- Developed crack-free residue acted as a type of conformal coating providing a consideration to assemble without conformal coating use for certain applications.
- Printing, wetting, voiding and reflow tests with components using developed paste indicated it could be used in electronics manufacturing which has been validated in production.