



TECHNICAL INFORMATION

CRACKS: THE HIDDEN DEFECT

by John Maxwell
AVX Corporation

Abstract:

Cracks in ceramic chip capacitors can be introduced at any process step during surface mount assembly.

Thermal shock has become a “pat” answer for all of these cracks, but about 75 to 80% originate from other sources. These sources include pick and place machine centering jaws, vacuum pick up bit, board depanelization, unwarping boards after soldering, test fixtures, connector insulation, final assembly, as well as defective components. Each source has a unique signature in the type of crack that it develops so that each can be identified as the source of error.

CRACKS: THE HIDDEN DEFECT

by John Maxwell
AVX Corporation

Introduction

Cracks in ceramic surface mount technology (SMT) components limit assembly reliability and yields. These cracks manifest themselves as electrical defects: intermittent contact, variable resistance, loss of capacitance and excessive leakage currents. Large visible cracks and the insidious micro crack are usually blamed on the soldering process by component vendors and the components themselves by the users. The actual sources of cracks include both solder processing and to a lesser extent, defective components; but other very significant sources exist as well.

Cracks can be introduced at any process step used to manufacture an assembly. These sources include thermal shock by the soldering and cleaning processes, pick and place machine centering jaws and vacuum pick up bit, board depanelization, unwarping boards after soldering, test fixtures, connector installation, final assembly, defective or wrong value components and cracked or missing solder joints due to board design. Many production areas will have most if not all crack sources present so one may obscure the others. Luckily each source of cracks has a unique signature such that even the type of pick and place machine is easily identified.

Thermal Shock

“Thermal shock” is the pat answer for all cracks but is responsible only 20-25% of the time with the other sources of defects making up the balance. When thermal shock is present, it can easily obscure all other crack sources so an understanding is needed for each type of defect to identify and eliminate them. Thermal shock is mechanical damage caused by a structure’s inability to absorb mechanical stress caused by excessive changes of temperature in a short period of time. This stress is caused by differences in CTE (coefficient of thermal expansion), δT (thermal conductivity) and the rate of change of temperature. CTE and δT are a function of the materials used in the component’s manufacture and the rate of change of temperature is dependent on the soldering process. Thermal shock is a complex issue that has been covered earlier in detail^{1,2} so only an overview of those cracks is presented.

Multilayer ceramic capacitors are sensitive to thermal shock due to device construction consisting of interleaved layers of ceramic dielectric and metal electrodes with metal terminations for electrical contact. This structure has been described earlier.³ (See Figures 1 and 2)

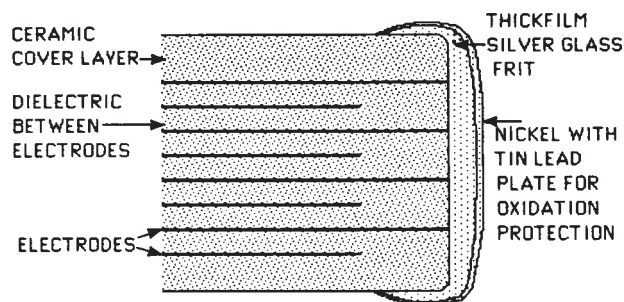

Figure 1. MLC Structure

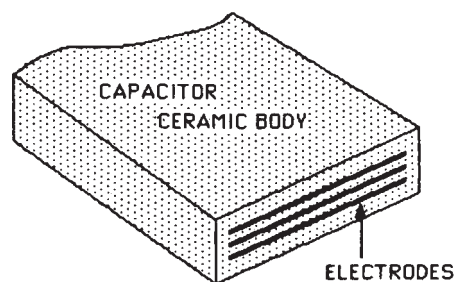

Figure 2. MLC Monolithic Structure Without Termination

TABLE I
CTEs AND δT s OF
COMPONENT MATERIALS

Material	CTE (ppm/°C)	δT (W/m ² °K)
Alloy 42	5.3	17.3
Alumina	≈7	34.6
Barium Titanate	9.5-11.5	4 to 5
Copper	17.6	390
Filled Epoxy	18-25	≈0.5
SiO ₂	.57	3.4
Nickel	15	86
Silver	19.6	419
Steel	15	46.7
Tantalum	6.5	55
Tin Lead Alloys	≈27	34

Compatible materials used in MLC manufacture have differences in CTE and δT that cause internal stress. When the temperature rate of change is too great, thermal shock cracks occur. These cracks are initiated where the structure is weakest and mechanical stress is concentrated. This is at or near the ceramic/termination interface in the middle of the exposed termination. Mechanical stress is greatest at the corners where the chip is strongest but cracks tend to start where the structure is weakest. When temperature rates of change are excessive, as in uncontrolled wave soldering, large visible U-shaped or thumb-nail surface cracks are formed.

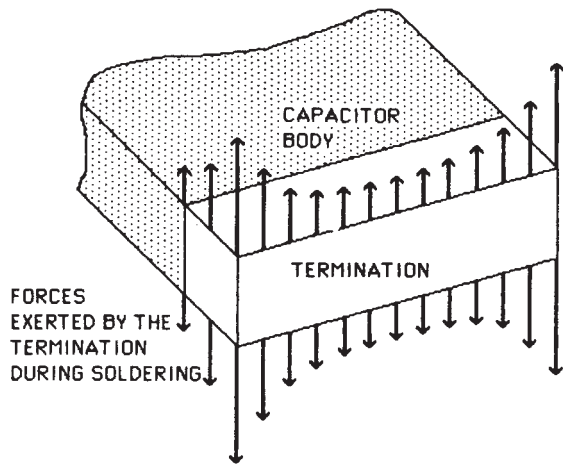

Figure 3. Stress Risers Caused by the Termination on the MLC Body

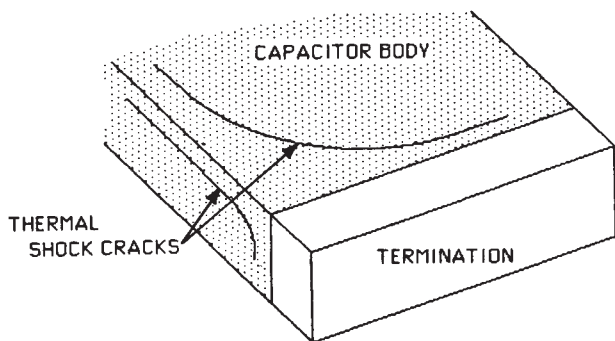

Figure 4. Extreme Thermal Shock Cracks in MLCs

Thermal shock has two manifestations, obvious visible cracks (Figure 4) and the more insidious, invisible micro crack (Figure 5). The same forces are involved but on a smaller magnitude so smaller cracks are formed. Again it starts in the middle of the exposed surface at or just under the ceramic/termination interface and propagates slowly with temperature changes or assembly flexure during handling. In a matter of weeks a micro crack can propagate through the ceramic causing opens, intermittents or excessive leakage currents, a time bomb due to processing (Figure 6).

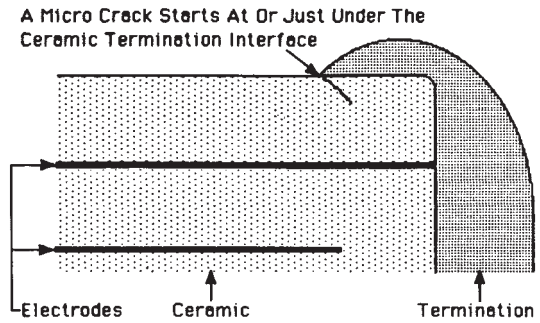

Figure 5. The Micro Crack Location

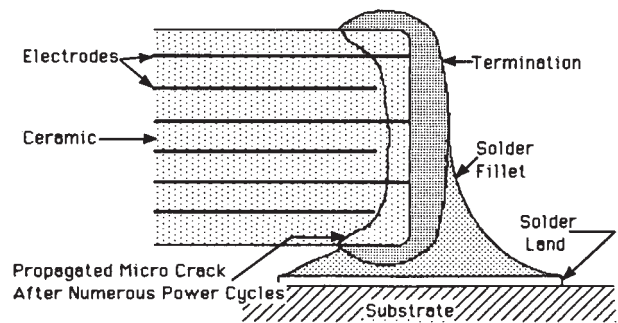

Figure 6. A Propagated Micro Crack After Power Cycling

Thermal shock cracks are always caused by improper solder processing or cleaning. Wave soldering is the biggest culprit because it has the highest heat transfer rate (using liquid metal) and the largest temperature changes which cause both visible and micro cracks. Vapor phase soldering has the second highest heat transfer rate and temperature changes which can induce micro cracks when inadequate preheat is used. Infrared (IR) reflow soldering has the lowest heat transfer rates and thermal shock is unheard of for this soldering technique. Assembly cleaning cannot be ignored because thermal shock can occur during heating or cooling. An assembly should be allowed to cool to less than 60°C before it is subjected to the cleaning process.

Pick and Place Machine Damage

Pick and place machine damage constitutes the largest source of defects in a manufacturing environment today. These defects are usually erroneously called “Thermal Shock Cracks” sending both the vendor and manufacturing groups down the wrong path looking for a solution. This damage is caused by the centering jaws or vacuum pick up bit with the frequency of damage time and shift dependent. With the exception of gross damage, pick and place machine cracks do not appear until after the part has been subjected to the soldering process but are very unique. These too are large, visible cracks and invisible internal damage that is also a processing time bomb.

Vacuum Pick-Up Bit

Damage or cracks caused by vacuum pick-up bits is straightforward and obvious (Figure 7). It usually consists of a crushed circular- or halfmoon-shaped area on the exposed surface of the chip and is usually quite rough with ragged edges or can be a visible impression of the placement bit. Additionally the halfmoon or circular areas will match the bit diameter. Another manifestation of bit damage occurs where solder paste is used on reflow soldered boards. Tensile cracks may be found originating on the board side of the component going from side to side in the middle of the part. These cracks may propagate to the top surface and will be rough or ragged with possible pieces of the capacitor burst from its bottom surface and trapped between the capacitor and board. This is a case where the solder paste has supported the capacitor ends but not the middle, allowing the unsupported component body to crack.

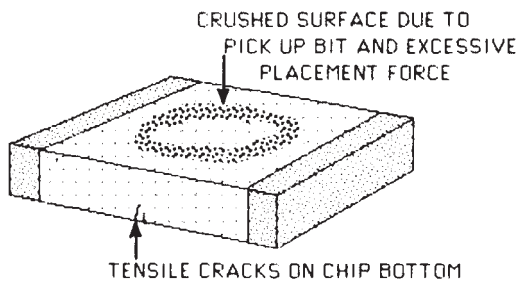

Figure 7. Placement Bit Damage With Tensile Cracks

This type of damage is caused by excessive Z-axis placement force of the bit that exceeds the rupture strength of the ceramic. Many pick and place machines use small bits (increased pounds/sq. inch) which compounds the problem by reducing the process window to avoid damage. There are two basic methods used for placement force: programmed Z-axis displacement, and pneumatic actuators. When Z-axis displacement is used for parts placement, component thickness variations, board (substrate) warpage, component land plating and solder paste thickness variations are the usual culprits. Pneumatic actuators have a separate set of problems that also include component thickness variations and warped boards. Air pressure variations within the plant can be a major cause of excessive placement pressure cracks. Also as the air cylinders age, they get sticky or suffer pressure loss, both of which are compensated for with increased air pressure and excessive force placement defects. Z-axis placement force is a process parameter that requires mandatory monitoring and control.

Centering Jaw Damage

Pick and place machines have gone through an interesting evolution from no centering jaws to centering jaws and now back to machines with no centering jaws. The newer machines are much faster and use machine vision to properly place parts instead of using mechanical alignment. Centering jaws (or mechanical alignment) will be with us for some time and will continue to cause problems. Pick and place machines come with two varieties of centering

jaws: top centering, and bottom centering. Each type has its own unique crack signature and will be discussed separately.

Top Jaws

Top centering jaw machines have the alignment jaws or tweezers as part of the pick up mechanism (Figure 8) such that the part is centered (aligned) when plucked from the component carrier (embossed tape, etc.) or during the travel time between pick up and placement. Capacitors, resistors, transistors and integrated circuits (IC) require different sizes of centering jaws which slow production rates with jaw changes. It is common practice to adjust a single jaw set to accommodate the full range of components which results in higher forces on smaller parts when the jaws are adjusted to center large ICs. Not only are higher forces used but the jaw contact areas are reduced so centering is done only on the IC body and not the leads. Now only a small portion of a capacitor's side and end surface area is used for centering which gives rise to pressures that exceed the rupture or tensile strength of the ceramic causing internal defects and visible cracks (Figure 9).

Barium titanate ceramics have tensile strengths in the range of 8-10,000 psi and rupture strengths of 10-15,000 psi. These numbers seem high until one realizes that a phonograph stylus exerts similar forces on vinyl records. A few ounces of force translates to thousands of psi when small surface areas are involved. Typical pick and place machine centering jaws are rather narrow, 40 mils (1 mm) is very common, which packs all of the force onto a small surface. Not only do the centering jaws have small contact area viewed from the top, the jaws only extend to a depth of 10-20 mils from the top surface to accommodate plastic molded transistor or IC bodies without interfering with their leads. We have the recipe for high speed assembly of cracked components.

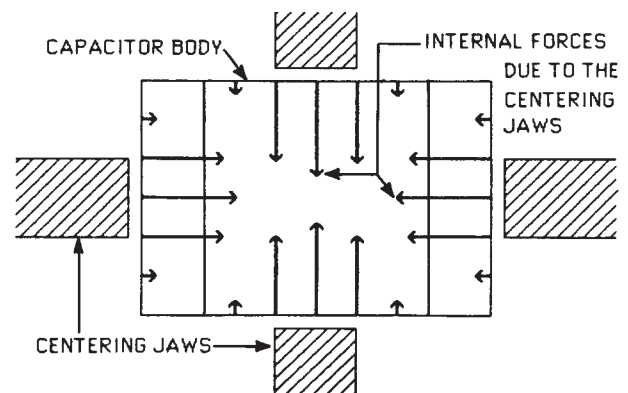

Figure 8. Top View of Capacitor Body, Centering Jaws and Force Concentration

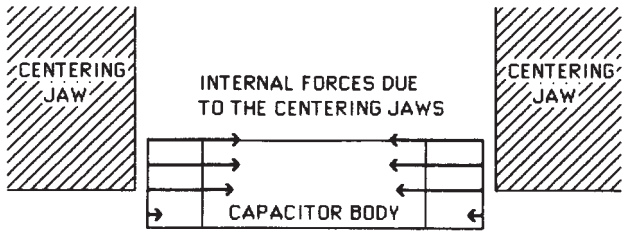

Figure 9. Side View of Capacitor Body, Centering Jaws and Force Concentration

These force concentrations from narrow centering jaws create large force or shear gradients where cracks develop. These cracks manifest themselves as visible surface cracks or internal cracks between two or three electrodes. Surface cracks originate along lines of maximum compression and ceramic displacement (Figure 10).

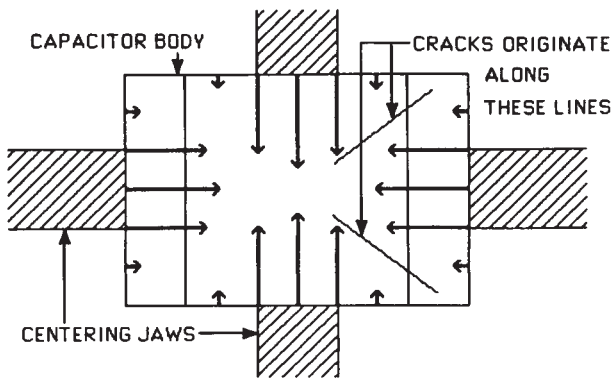

Figure 10. Surface Crack Origins

Top centering jaw machines generate surface cracks that typically originate or end under the termination while thermal shock cracks radiate away from the termination with a thumbnail- or U-shape. Centering jaw cracks will typically not extend beyond 1/3 to 1/2 of the chip length. These are quick clues to determine the source of cracks. Figure 11 illustrates typical top centering jaw damage after soldering.

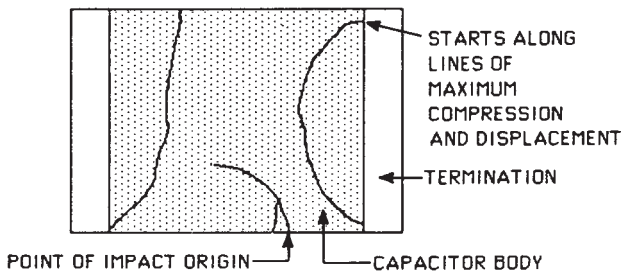

Figure 11. Typical Surface Cracks from Top Centering Jaws

As with thermal shock, there is the insidious internal crack from centering that is generated when the process is just a little out of control which is like being just a little pregnant, it doesn't show up until later (Figure 12). This defect manifests itself as excessive leakage that shows up many months after assembly. There are no external visible signs and these cracks are very difficult to find with DPA (destructive physical analysis) techniques. This is because the crack is very small and only extends across two or three electrodes in the capacitor body making it very easy to polish past the defect site.

Some impact site cracks are easy to find with DPA when the centering jaw forces are low enough to just cause invisible damage. Typically these cracks have obvious origins 10-15 mils below the top surface which will be the bottom of the centering jaws, again the region of maximum stress gradients. These cracks may be deeper than 10-15 mils depending on the centering jaw depth but they will have their origins at the bottom of the jaw.

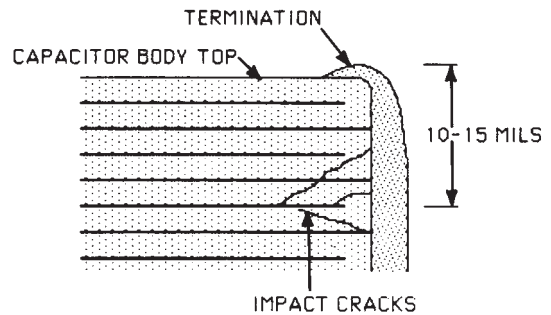
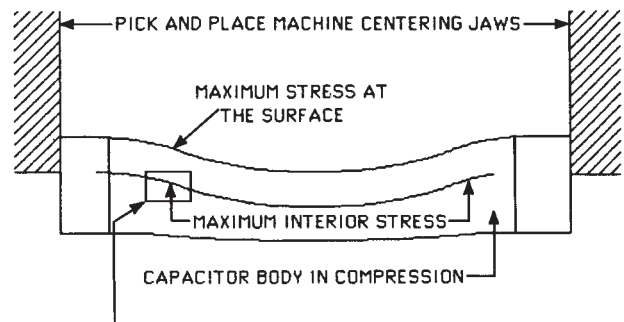

Figure 12. Typical Internal Centering Jaw Damage

Inter-electrode defects are the most difficult to find with DPA but they too occur at the same depth as the more obvious cracks, at the bottom depth of the centering jaws. These small cracks are again 10-15 mils below the surface (or jaw depth), near the maximum stress gradients exerted by the centering jaw. The capacitor body is slightly deformed by the compressive forces of the centering jaws. This deformation is similar to pressing on the ends of a deck of cards, and has three inflection points for this type of compression. A small crack will form between two or possibly three electrodes when the ceramic layer ruptures, relieving the stress. A small internal defect that is very difficult to find but can still kill reliability (Figures 13 and 14).



See Figure 14.

Figure 13. Capacitor Under Compression from Centering Jaws

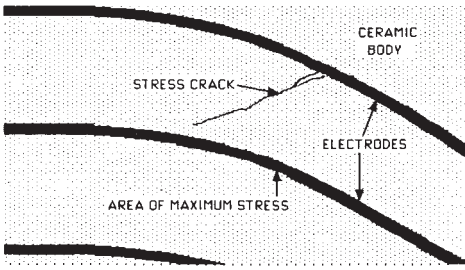

Figure 14. Exaggerated Inter-Electrode Distortion

Ceramics used to make MLC capacitors have excellent abrasion characteristics which cause centering jaw wear (Figure 15). Once this wear becomes pronounced (a tenth of a mil or so), a new type of crack can appear even though the equipment has not generated defects in the past. This problem shows up when capacitor lots or vendors are changed and the parts are now slightly thicker. Now all of the force is concentrated in the top few mils, the rupture strength is exceeded and the part cracks. Worn centering jaw induced cracks are typically in the middle of the part extending from side to side on the top surface (Figure 16).

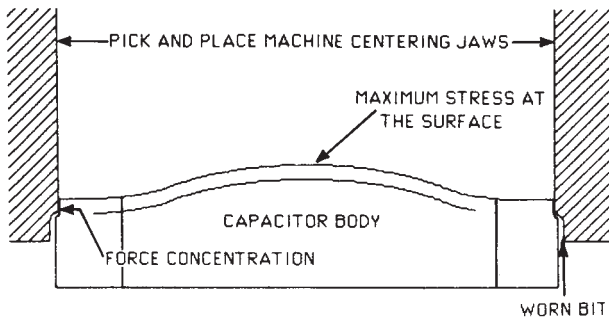

Figure 15. Worn Centering Jaws and Capacitor Distortion

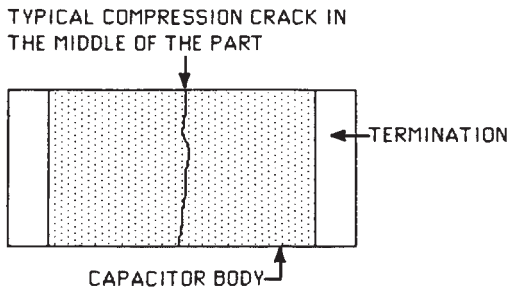

Figure 16. Typical Worn Centering Jaw Crack

Another type of damage caused by narrow top centering jaws comes about when the part is slightly rotated in its embossed tape pocket. Now all centering or alignment forces are concentrated at the sharp corners of the jaws causing chip-outs at the impact sites. There may be cracks radiating away from the impact sites on the top surface that show up after exposure to soldering temperatures (Figures 17 and 18).

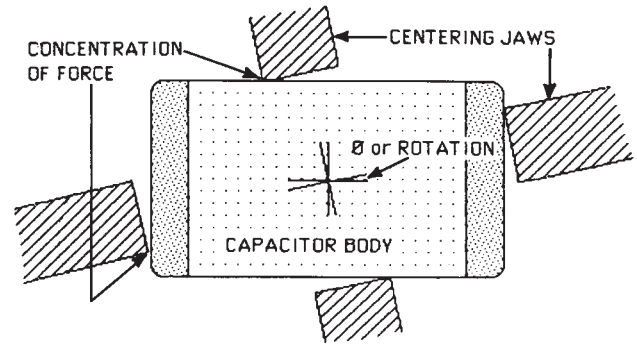

Figure 17. Misalignment of Component

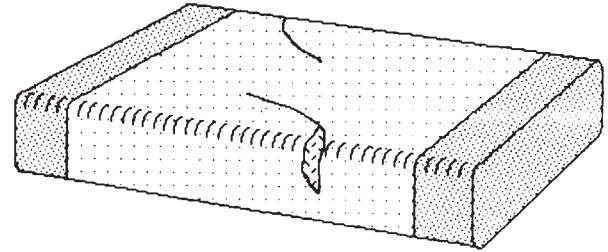

Figure 18. Resulting Damage

Bottom Centering Jaws

We're not out of the woods yet with pick and place machine damage. Bottom centering jaws found on some high volume chip shooting machines also have a unique centering stress crack. These cracks appear and disappear at random intervals and have been tracked to debris buildup on the component pedestal (Figure 19). When debris is present, the component will not be flat or square to the centering jaws, concentrating the alignment forces on a corner causing a displacement crack.

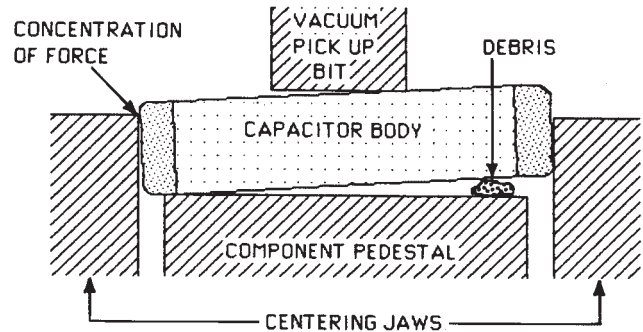

Figure 19. Bottom Centering Jaws With Debris

This crack propagates from side to side on the top surface (Figure 20) and is similar to surface rupture cracks caused by worn top centering jaw machines. Bottom centering cracks also extend along one or both sides of the part near the surface into the termination. These cracks are eliminated with a rigid cleaning and maintenance regime.

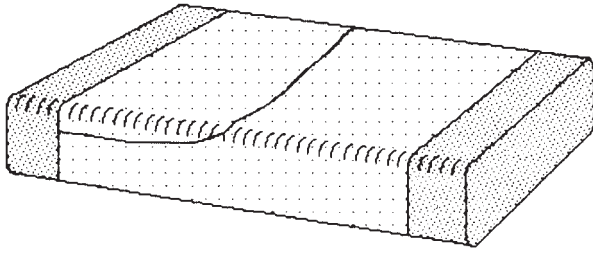

Figure 20. Typical Bottom Centering Crack

Complete process control is mandatory in the placement process to eliminate damage. This includes proper periodic maintenance and monitoring of all process variables. Using mechanisms the largest possible pick up bit, lowest possible placement force and centering jaws that spread alignment forces over the entire side surfaces of the component are changes that may slow the placement process but it is preferred to high speed assembly of damaged components.

Plant air pressure, board warpage and thickness variations, solder paste thickness on land patterns, uniformity of solder paste thickness after screening, adhesive volume control and placement force are parameters that may need control. It is always best to monitor all in the beginning and decide later which are not important for a manufacturing area instead of controlling none and trying to find what is important when failures occur.

Warp Cracks

Cracks caused by bending a soldered assembly during depanelization, test, component placement on the opposite side, connector assembly, final product assembly or unwarping a board after soldering all fall under the heading "WARP CRACKS" and are as unique as thermal shock or placement cracks. In each case, the tensile strength of the ceramic has been exceeded and a crack is formed. These cracks do not need thermal processing such as soldering to propagate but occur with an audible snap.

The primary cause of cracks is the actual board

warpage but solder joint mass has an effect on when cracks occur. Excessive solder transfers all stress to the component and too little solder causes early fatigue in the joint. Proper solder joint formation is a function of the soldering process, pad design and mass of solder present and will be covered in another paper.

Allowable bending of finished assemblies is another specification that cannot be an extension of thru hole technology because the entire component is exposed to stress. There are two possible approaches to board bending specifications: a linear mils/inch, or a more realistic minimum bend radius. (See insert.)

Minimum bend radius has a very small allowable deflection in a short segment length but allows a large deflection in long assemblies. For example, a one-inch long segment can have no more than 8.4 mils of uniform bend with a 60-inch minimum bend radius but a four inch long board can have 124 mils of uniform bend. Uniform bend is where the board fits smoothly along the radius of a circle. If there are rigid components like large ICs (integrated circuits), transformers or connectors, then less deflection is allowed for a given board length to eliminate defects. A derivation of allowable deflection based on assembly length and bend radius is in the box below.

Board Depanelization

Manufacturing efficiency requires multi-up or multiple assembly panels but the potential for damage dictates single module assembly. Multi-up panels are possible but care must be taken in the depanelization process. There are six basic schemes to breakout multi-up panels but each has disadvantages.

1) Hand break out modules: Typically this approach uses perforations or a scribed line between modules so they can be broken apart by hand after soldering and cleaning. This technique has no uniformity in applied pressure or pressure application and will have erratic quality and yields. Not a viable process for volume production when operators have different yields.

2) Scissor shear: This is a carry-over for thru hole

Insert

MAXIMUM BOARD DEFLECTION FOR A GIVEN MINIMUM BEND RADIUS

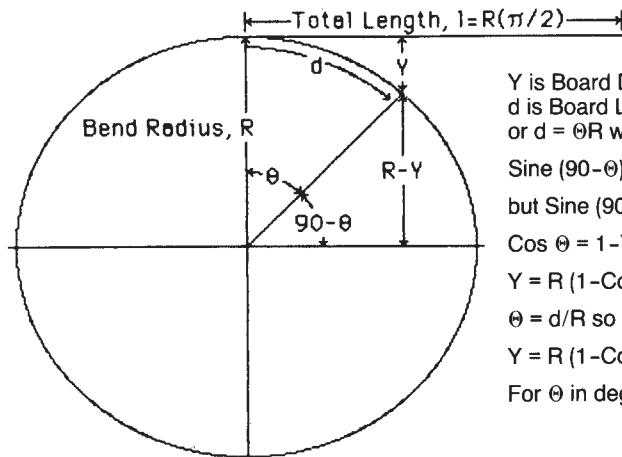

Y is Board Deflection
d is Board Length
or $d = \theta R$ with θ in radians

$\text{Sine } (90-\theta) = (R-Y)/R = 1-Y/R$
but $\text{Sine } (90-X) = \text{Cos } X$ so
 $\text{Cos } \theta = 1-Y/R$ or
 $Y = R(1-\text{Cos } \theta)$
 $\theta = d/R$ so
 $Y = R(1-\text{Cos } (d/R))$
For θ in degrees, $\theta = 90(d/R)/(\pi/2)$

EXAMPLES

MINIMUM BEND RADIUS = 60"

A) 4" Long Board

$$Y_{\text{max}} = 60(1-\text{Cos } (4/60))$$

$$= 60(1-.99794)$$

$$= .1236"$$

B) 1" Segment

$$Y_{\text{max}} = 60(1-\text{Cos } (1/60))$$

$$= 60(1-.99986)$$

$$= .0084"$$

assembly techniques and is actually an extension from a sheet metal shop. There is a great deal of board bending and tearing near shear blades that can crack components and solder joints. This shearing technique can be used with care but at the loss of board real estate by placing components away from flexing edge and corners. Components located near assembly corners will receive the greatest stress because the corners are the least supported portion of the board and each corner is cut twice, once in the X direction and once in Y. Cracks generated during board shearing typically run diagonally across the top surface from corner to corner.

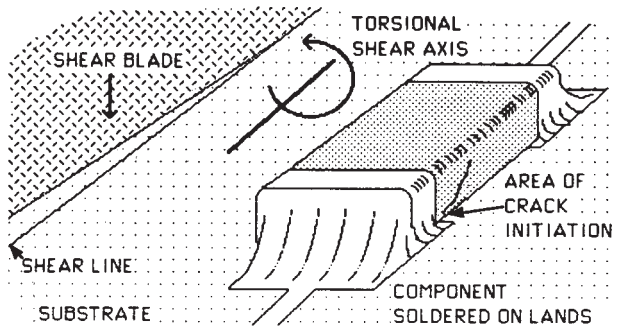

Figure 21. Typical Board Shearing Crack

Isolating components from board corners and away from edges is the best way to minimize shear damage and leave room for fixturing to reduce movement during the shearing process. Prerouting corners will further reduce stress and flexure in the critical corner areas. Leaving a 200-mil margin has been used successfully to eliminate damage while a 20-mil margin has always failed (Figure 22).

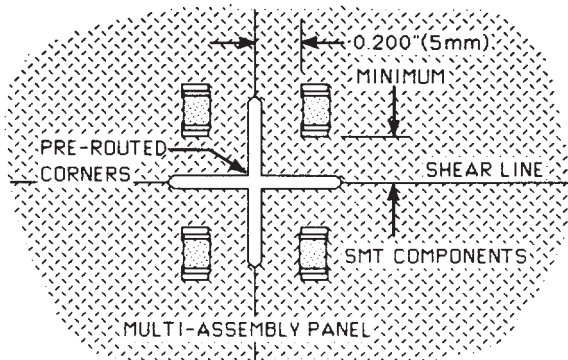

Figure 22. Prerouted Corners to Relieve Stress

3) Rolling blade shear (pizza cutter): Too much flexure occurs when a rolling cutter is used because all cutting forces are concentrated in a small moving area. It is very difficult to fixture a board to minimize damage when rolling shears are used; they are best reserved for pizza parlors.

4) Blanking or die shearing: Board flexure is still a problem but not to the extent of scissor or rolling shears because there is no tearing of the substrate or bending of corners. The entire edge of the module is supported during the shearing process which restricts movement. Components still need to be isolated from the edge and to use thinner substrate material. (.031" or possibly .047") which is weaker and easier to cut. Large boards are difficult to support and fixture while thick substrate material transfers too much stress to the components. This process

is best used on blank boards or small modules on thin substrates with isolated components.

5) Sawing: Board sawing does not induce the extreme board flexure during the cutting process, eliminating component stress and damage. Gang saws are available that are very fast, two passes and the assembly is done. Semiconductor industry needs have been supplied with a wide variety of programmable saws that fill the needs of small runs or prototyping of SMT assemblies. Unfortunately saws are not easily used with odd shapes or curves; these shapes need to be prerouted prior to assembly driving up substrate cost. Saws are best suited for square or rectangular boards.

6) Water jet cutting: This is the most flexible SMT assembly cutting technique available with the simplest fixturing but has the highest capital expense for equipment, but cost is coming down.

Shears should be avoided if at all possible to depanelize SMT assemblies but if they must be used, isolate components from edges and corners and prerout corner areas to minimize damage. Saws or water jet cutting do not induce damage and they are preferred methods for depanelization.

Warping Boards After Soldering

This is a broad subject area because it includes placing final assemblies in test fixtures, installing connectors or other large components, stacking assemblies in trays or 2 x 4s with slots to await further processing, final product assembly, flattening an assembly to eliminate warp after soldering or mounting components on the second side after soldering the first side. This entire class of defects has similar failure modes and induced cracks due to excessive substrate bending and component stress.

Post soldering assembly handling can be a major source of cracks because components are oriented across stress gradients instead of parallel to the gradient. When tooling holes on the assembly do not meet the respective pins on a test system or pick and place machine, the tendency is to force fit the assembly. The "use a bigger hammer to make it fit" syndrome does not work with SMT assemblies, latent defects are the only result. Improper storage of soldered assemblies can be another source of cracks if assemblies are allowed to sag or warp when placed in trays or vertical slots. Warping a board as it is screwed into a chassis or attaching connectors or other large components can have the same effect, cracked components when oriented across stress gradients.

The resulting cracks occur very quickly with an audible snap. Depending on board warp, direction and component orientation, these defects propagate to relieve stress. Cracks initiate at the ceramic termination interface where ceramic movement is restricted by the termination and solder fillet. Because ceramic fails in the tensile mode at lower forces (10kpsi tensile vs 15kpsi compression), crack initiation will typically be at maximum tensile force sites as shown in Figure 23.

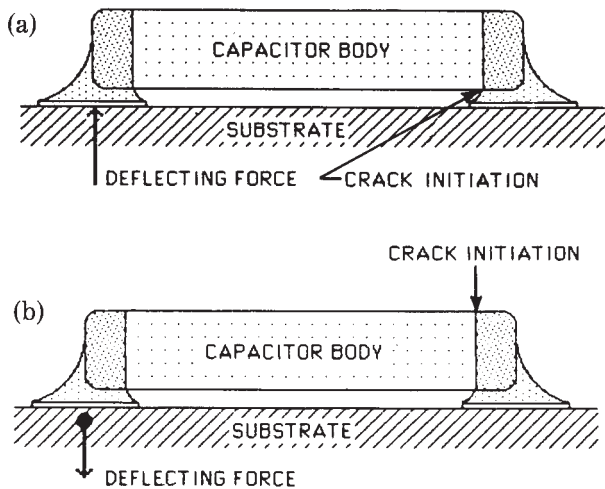

Figure 23. Crack Initiation Sites

The resulting crack propagates from the initiation site to the termination at about a 45° angle. When DPA is done on this type it is confused with thermal shock or possible pick and place damage. Thermal shock cracks typically propagate from termination to termination and pick and place cracks under the termination exhibit multiple fractures while board warp cracks typically consist of a single crack.

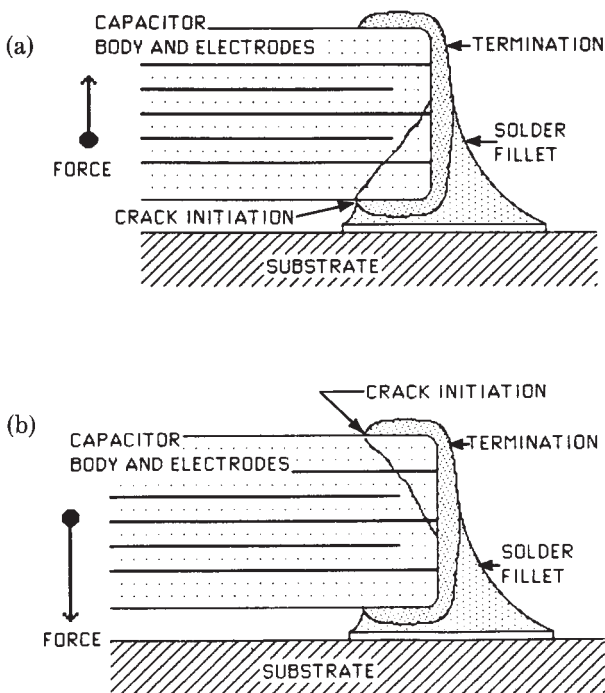

Figure 24. Typical Board Warpage Cracks

Defective Components

There are three basic types of visible internal defects in MLC (multilayer ceramic) capacitors that impair reliability: inter-electrode voids, firing cracks and knit line cracks.

Each of these failures cause excessive leakage currents, impairing assembly reliability.

- 1) Inter-electrode voids are caused by high porosity of the ceramic or voids in the dielectric layer between opposite electrodes. This void becomes a short leakage current path and then a latent electrical defect.
- 2) Firing cracks have the characteristic of being perpendicular to the electrodes and typically originate at an electrode edge or end. Mechanical overstress cracks such as thermal shock and external damage originate and propagate at angles near 45°. If the DPA shows vertical cracks, then they are probably from firing.
- 3) Knit line cracks extend from an electrode end to the opposite termination causing a latent leakage path. Delaminations and single layer voids do not cause failures directly but are much more sensitive to mechanical stress which can rupture inter-electrode dielectric layers which then becomes the latent leakage path.

Conclusions

Every step of the SMT assembly process can induce defects. Sub ppm defects demands that these potential sources be identified and controlled to maintain high yields. Adding SMT assembly to a thru hole manufacturing area without understanding component process sensitivity leaves only a bad impression of surface mount benefits. Defective components do exist but it's only a small percentage and thermal shock is not the pat answer or major source of defects. Pick and place machines and post soldering handling induce the majority of defects.

Thermal shock cracks originate at the surface and propagate to the interior, mechanical overstress damage can start at the surface or the interior; but both thermal shock and overstress cracks propagate at angles near 45°. Defective components have voids or cracks that are perpendicular or parallel to interior electrodes.

Surface mount technology holds many benefits but there is no room for sloppy practices; now SMT assemblies need the control that semiconductor processing uses. Remember, most SMD components are the same ones found in packages that have been used reliably for decades. Now extreme care must be taken at the start of a design to identify all high stress areas and orient components to minimize possible damage. A design with minimum stress will always have higher yields and reliability.

References

1. B.S. Rawal, et. al, "Factors Responsible for Thermal Shock Behavior of Chip Capacitors," AVX Technical Information Series, 1987.
2. J. Maxwell, "Surface Mount Soldering Techniques and Thermal Shock in MLCs," AVX Technical Information Series, 1987.
3. M. Kahn, "Multilayer Ceramic Capacitors - Materials and Manufacture," AVX Technical Information Series, 1981, 5 pp.

NOTICE: Specifications are subject to change without notice. Contact your nearest AVX Sales Office for the latest specifications. All statements, information and data given herein are believed to be accurate and reliable, but are presented without guarantee, warranty, or responsibility of any kind, expressed or implied. Statements or suggestions concerning possible use of our products are made without representation or warranty that any such use is free of patent infringement and are not recommendations to infringe any patent. The user should not assume that all safety measures are indicated or that other measures may not be required. Specifications are typical and may not apply to all applications.

USA

AVX Myrtle Beach, SC Corporate Offices

Tel: 843-448-9411
FAX: 843-626-5292

AVX Northwest, WA

Tel: 360-699-8746
FAX: 360-699-8751

AVX North Central, IN

Tel: 317-848-7153
FAX: 317-844-9314

AVX Mid/Pacific, MN

Tel: 952-974-9155
FAX: 952-974-9179

AVX Southwest, AZ

Tel: 480-539-1496
FAX: 480-539-1501

AVX South Central, TX

Tel: 972-669-1223
FAX: 972-669-2090

AVX Southeast, NC

Tel: 919-878-6223
FAX: 919-878-6462

AVX Canada

Tel: 905-564-8959
FAX: 905-564-9728

EUROPE

AVX Limited, England European Headquarters

Tel: ++44 (0) 1252 770000
FAX: ++44 (0) 1252 770001

AVX S.A., France

Tel: ++33 (1) 69.18.46.00
FAX: ++33 (1) 69.28.73.87

AVX GmbH, Germany - AVX

Tel: ++49 (0) 8131 9004-0
FAX: ++49 (0) 8131 9004-44

AVX GmbH, Germany - Elco

Tel: ++49 (0) 2741 2990
FAX: ++49 (0) 2741 299133

AVX srl, Italy

Tel: ++390 (0)2 614571
FAX: ++390 (0)2 614 2576

AVX Czech Republic, s.r.o.

Tel: ++420 (0)467 558340
FAX: ++420 (0)467 558345

ASIA-PACIFIC

AVX/Kyocera, Singapore Asia-Pacific Headquarters

Tel: (65) 258-2833
FAX: (65) 350-4880

AVX/Kyocera, Hong Kong

Tel: (852) 2-363-3303
FAX: (852) 2-765-8185

AVX/Kyocera, Korea

Tel: (82) 2-785-6504
FAX: (82) 2-784-5411

AVX/Kyocera, Taiwan

Tel: (886) 2-2696-4636
FAX: (886) 2-2696-4237

AVX/Kyocera, China

Tel: (86) 21-6249-0314-16
FAX: (86) 21-6249-0313

AVX/Kyocera, Malaysia

Tel: (60) 4-228-1190
FAX: (60) 4-228-1196

Elco, Japan

Tel: 045-943-2906/7
FAX: 045-943-2910

Kyocera, Japan - AVX

Tel: (81) 75-604-3426
FAX: (81) 75-604-3425

Kyocera, Japan - KDP

Tel: (81) 75-604-3424
FAX: (81) 75-604-3425

Contact:



<http://www.avxcorp.com>

S-CHD00M900-R